

Your technological partner

Powertrain Solutions & System Integrators

- Controladores HV 300-800V
- Motores AC, PMAC, IPM
- Contactores low & HV 12-500V
- Controladores AC, PMAC, BLDC 24-144V
- Convertidores DC 300-500W

<p>Proyectos de emobility Automatización Industrial y AGV Manutención y Logística Vehículos Industriales Mantenimiento y Gestión de Baterías Manipulación y Salas de carga</p>	<p>SAI's y Equipos de Telecomunicaciones Energías Renovables Aplicaciones Ferroviarias Náutica y Industria Naval Vehículos agrícolas y construcción Señalización y Sistemas CCTV</p>
---	---



R&D e Integradores para el vehículo eléctrico y la automatización industrial

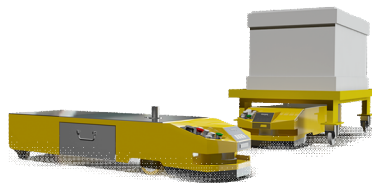

Ingeniería para la implementación de salas de carga y el mantenimiento de flotas

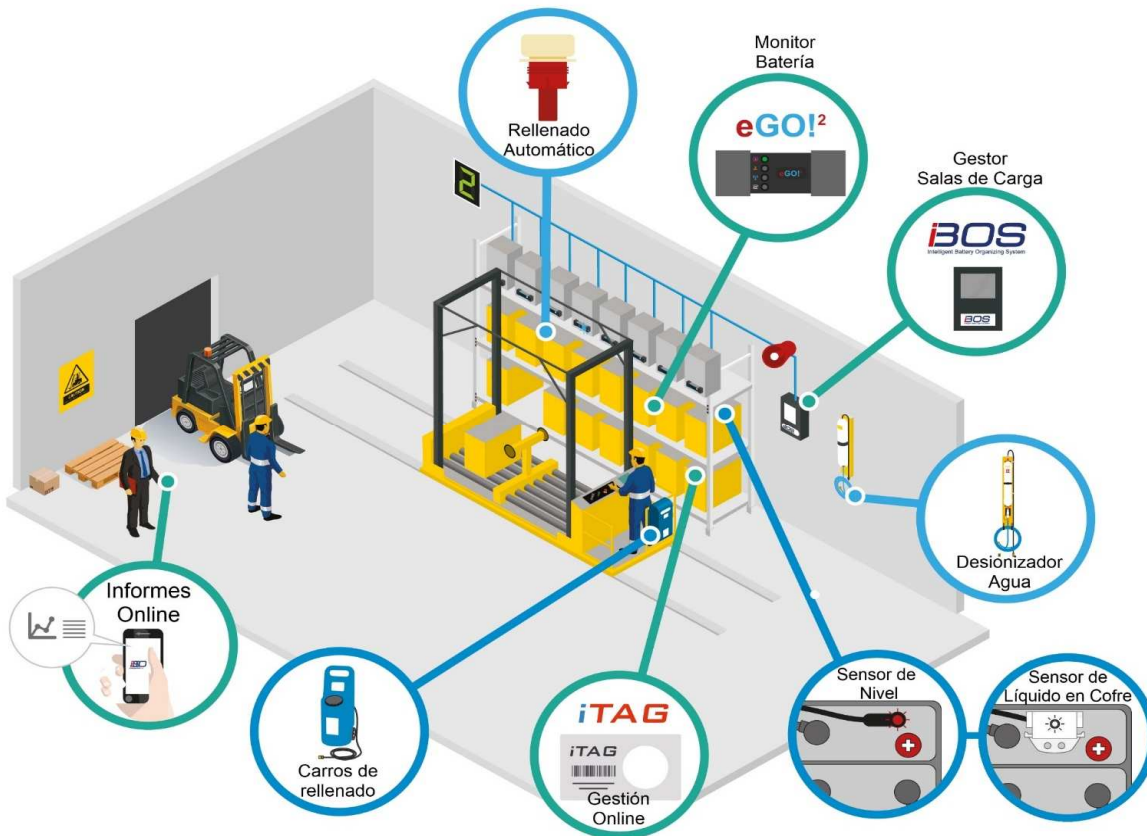

Soluciones a medida para cada aplicación

	Página
CONECTORES DE BATERÍA	
 *Conectores de potencia bipolares planos.....	4 - 5
 *Conectores especiales	6 - 7
*Conectores DIN REMA	8 - 9
*Conectores Antideflagrantes ExProof	10
*Paros de emergencia y Timones REMA	10
CONEXIONES, TORNILLOS Y SALIDAS DE BATERÍA	12
 EQUIPOS PARA EL MANTENIMIENTO DE BATERÍAS	12 a 16
sensor de nivel electrolito, desionizador, relleno de baterías, carros	
 PROTECTORES DE BORNES, DISTRIBUIDORES y PASAMUROS ...	17 a 22
CONTACTORES DE POTENCIA de 60A a 3000A	
*Serie SW60 - 80A, máx.120V	23
*Serie SW80 - SU60 100A, máx.240V	24 - 25
*Serie SW180 - SU80 150A, máx.240V	26 - 27
*Serie SW200 - SU280 250A, máx.240V	28 - 29
*Paros emergencia serie ED - SD	30
 CONTACTORES DE POTENCIA TELECOM hasta 3000A	32 - 33
 INSTRUMENTACIÓN, FAROS, CONVERTIDORES, VARIADORES...	34 a 39
 MOTORES PMAC	40
 VARIADORES CC, AC y PMAC	41 - 42
 VARIADORES Imanes Permanentes, BLDC y AC	43 - 45
 VARIADORES Imanes Permanentes y AC	46 - 47
 MOTORES, MOTOBOMBAS, MOTORUEDAS CC y AC	46 - 47
FUSIBLES y PORTAFUSIBLES	49
CONVERTIDORES DC-DC	49
 CARGADORES DE ALTA FRECUENCIA	50
MATERIAL DE SEÑALIZACIÓN	
* Blue Spot, luz perimetral, Flecha	50
* Faros destellantes, Faros de trabajo	51 - 52
* Zumbadores de marcha atrás.....	53
* Sistemas de CCTV para la marcha atrás	54 - 55
	

16.- CONECTORES DE POTENCIA BIPOLARES REMA

2026

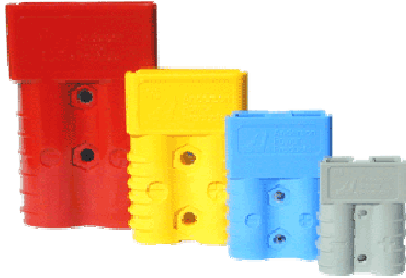

en mm	SR50	SR175	SR350	SRX350
A	19.0	28.5	28.5	28.5
B	6.4	11.0	35.0	35.0
C	18.2	27.8	35.0	--
D	36.5	55.6	69.8	85.7
E	47.6	79.4	108.0	125.4
F	80.9	133.3	182.6	200.0
G	11.5	19.0	27.0	--
H	15.9	25.4	33.3	33.3

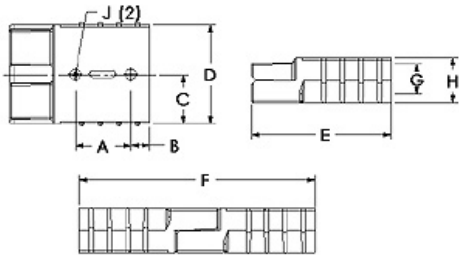

Ref.	Artículo	P.V.P.
Conector SR50 - sección #6 - 13,3mm		
78180-00	GRIS	5,50
78184-00	ROJO	5,50
78181-00	NEGRO	6,00
78265-05	Contacto 3-5mm ² AWG10/12 para SR50 (5900)	1,70
78265-10	Contacto 8mm ² AWG8 para SR50 (5952)	1,70
78265-00	Contacto 13,3mm ² AWG6 para SR50 (5915)	1,70

Conector SR175 - sección #1/0 - 53,5mm		
78220-00	GRIS	11,00
78224-00	AZUL	13,00
78236-00	ROJO	13,00
78268-00	Contacto AWG 4 21,2mm ² para SR175	4,00
78270-01	Contacto AWG2 33,6mm ² para SR175	3,50
78270-00	Contacto AWG1/0 53,5mm ² para SR175	3,50

Conector SR350 - sección #2/0 - 67,4mm		
78300-00	GRIS	21,00
78304-00	AZUL	21,00
78308-00	ROJO	21,00
78273-00	Contacto AWG1/0 53,5mm ² para SR350	7,00
78275-00	Contacto AWG2/0 67,43mm ² para SR350	7,00
78275-05	Contacto AWG3/0 85,01mm ² para SR350 = 916-BK	14,00
78275-10	Contacto AWG4/0 107mm ² para SR350 = 908-BK	25,00

Conector SRX350 - sección #2/0 - 67,4mm		
78100-00	GRIS	55,00
78105-00	AZUL	55,00
78110-00	ROJO	55,00
78120-00	NEGRO	55,00

Conector SRE160 - sección 50mm		
78028-00	GRIS	15,00
78030-00	AZUL	15,00
78036-00	ROJO	15,00
78040-00	NEGRO	17,00
78282-00	Contacto 25mm ² para SRE160	5,00
78283-00	Contacto 35mm ² para SRE160	5,00
78281-00	Contacto 50mm ² para SRE160	5,00

Conector SRE320 - sección 70mm		
78331-00	GRIS	23,00
78336-00	AZUL	23,00
78341-00	ROJO	23,00
78350-00	NEGRO	23,00
77951-00	Contacto 50mm ² para SRE320/SRX350	7,50
78285-00	Contacto 70mm ² para SRE320/SRX350	7,50
78287-00	Contacto 95mm ² para SRE320 /SRX350	9,00
78285-10	Contacto AWG 4/0 107mm ² para SRE320/SRX350 (6356)	33,00

ACCESORIOS

SB50-HDL	EMPUÑADURA ROJA SR50	6,20
78290-04	EMPUÑADURA GRIS SRE160-SR175 4 tornillos M6x36 +tuercas	10,00
78297-04	EMPUÑADURA GRIS SRE320-SR350 4 tornillos M6x45 +tuercas	10,00
78291-04	EMPUÑADURA ROJA SRE160-SR175 4 tornillos M6x36 +tuercas	10,00
78298-04	EMPUÑADURA ROJA SRE320-SR350 4 tornillos M6x45 +tuercas	10,00
134G1	PROTECTOR CONTRAPOLVO SR50	4,90
134G2	PROTECTOR CONTRAPOLVO SR175	8,50
134G3	PROTECTOR CONTRAPOLVO SR350	9,70
6344	JUEGO CONTACTOS AUXILIARES SRX/SER 2x30A	5,15
75071-10	TOMA DE AIRE SRX175 / SRE160	16,40
75071-11	TOMA DE AIRE SRX350 / SRE320	16,40

2.- CONECTORES DE POTENCIA BIPOLARES ANDERSON POWER PRODUCTS

2026



en mm	SB50	SB175	SB350	SBX350
A	19.0	28.5	28.5	28.5
B	6.4	11.0	35.0	35.0
C	18.2	27.8	35.0	--
D	36.5	55.6	69.8	85.7
E	47.6	79.4	108.0	125.4
F	80.9	133.3	182.6	200.0
G	11.5	19.0	27.0	--
H	15.9	25.4	33.3	33.3
J \varnothing	3.7	6.7	6.7	6.7

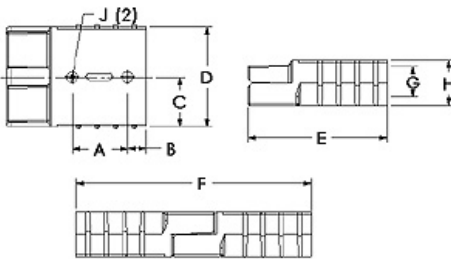

Ref.	Artículo	P.V.P.
Conector SB50 - sección #6 - 13,3mm		
6319	GRIS	5,50
6331G1	ROJO	5,50
6331G3	NEGRO	7,60
6331G5	AZUL	12,00
6331G7	AMARILLO	12,00
Conector SB175 - sección #1/0 - 53,5mm		
6325G1	GRIS	16,00
6326G1	AZUL	30,00
6329G1	ROJO	16,00
6327G1	NARANJA	37,50
6328G1	AMARILLO	37,50
Conector SB350 - sección #2/0 - 67,4mm		
6320G1	GRIS	32,50
6321G1	AZUL	32,50
6322G1	ROJO	32,50
6324G1	VERDE	71,00
Conector SBX350 - sección #2/0 - 67,4mm		
6345G1	GRIS	55,00
6346G1	AZUL	55,00
6347G1	ROJO	55,00
6348G1	VERDE	55,00
6363G1	NEGRO	55,00
Conector SBE160 / SBX175 - sección 35mm		
E6374G2	GRIS	17,50
E6375G2	AZUL	17,50
E6379G2	ROJO	17,50
E6389G2	NEGRO	17,50
E6391G2	VERDE	35,00
Conector SBE320 - sección #2/0 - 67,4mm		
E6334G1	MARRON	77,00
E6345G1	GRIS	35,50
E6346G1	AZUL	35,50
E6347G1	ROJO	35,50
E6348G1	VERDE	77,00
E6363G1	NEGRO	35,50
ACCESORIOS		
SB50-HDL	EMPUÑADURA ROJA SR50	6,20
995G1	EMPUÑADURA GRIS SRE160-SR175	10,60
995G2	EMPUÑADURA GRIS SRE320-SR350	10,60
995G3	EMPUÑADURA ROJA SRE160-SR175	10,60
995G4	EMPUÑADURA ROJA SRE320-SR350	10,60
134G1	PROTECTOR CONTRAPOLVO SR50	4,90
134G2	PROTECTOR CONTRAPOLVO SR175	8,50
134G3	PROTECTOR CONTRAPOLVO SR350	9,70
6344	KIT 2 contactos 30A SRX / SRE	5,15
441G3	KIT 4 contactos 20A 4mm ² SRX y SBE160/320	22,70
441G1	KIT 4 contactos 20A 1,5-2,5mm ² SRX y SBE160/320	26,10
441G2	KIT 4 contactos 20A 0,75-1,5mm ² SRX y SBE160/320	22,70
4850G6	KIT 4 contactos 7A 0,25-0,50mm ² SBE's (requiere 2 kits x SBE)	23,90
6396G1	TOMA DE AIRE SBX / SBE	18,00



Ref.	Artículo	P.V.P.
Conector SB120 - sección #2 - 33,6mm		
6800G1	GRIS	31,00
6802G1	ROJO	31,00
SB50HDL	Empuñadura T roja para SB50-SBE120	6,20
Versión para PCB		
6810G1-bk	Carcasa SB120 GRIS	12,00
6810G3-bk	Carcasa SB120 ROJA	12,00
120BBS	Contacto BUSBAR + tuerca para SB120 - MOQ 60 pcs	41,00

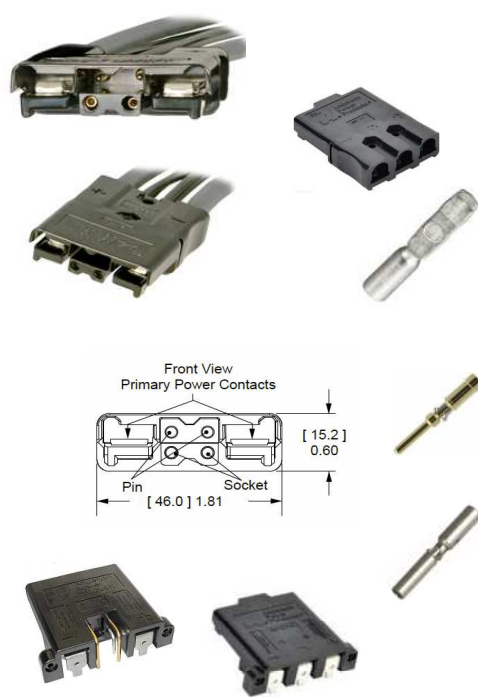

Conector SBE80 - sección 16mm - Opción 2, 4, 8 auxiliares		
SBE80RED16MM	ROJO 16mm con agarracables	25,00
SBE80HDL	Empuñadura roja para SBE80	6,20
Contactos auxiliares		
6344	KIT 2 contactos 30A SRX / SRE	5,15
441G3	KIT 4 contactos 20A 4mm2	22,70
441G1	KIT 4 contactos 20A 1,5-2,5mm2	26,10
441G2	KIT 4 contactos 20A 0,75-1,5mm2	22,70
4850G6	KIT 4 contactos 7A 0,25-0,50mm2 (requiere 2 kits x SBE) x2	23,90
4827G6	Carcasa PPMX 1x4 auxiliares 7A	3,00

Conectores SBS75X Bipolar + 4 auxiliares 20A y Tripolar 110A		
SBS75XBLK-bk	Carcasa negra SBS75X 2 polos + 4 auxil.- MOQ 50 pcs	15,00
SBS75XBRN-bk	Carcasa marrón SBS75X 2 polos + 4 auxil.- MOQ 50 pcs	15,00
SBS75GBLK-bk	Carcasa negra SBS75G 3 polos 110A - MOQ 50 pcs	15,00
SBS75GBRN-bk	Carcasa marrón SBS75G 3 polos 110A - MOQ 50 pcs	15,00
Contactos de potencia		
1339G2	Contacto 16mm2 SBS75 - MOQ 100 pcs	6,45
1339G5	Contacto 10mm2 SBS75 - MOQ 100 pcs	7,50
1339G3	Contacto 6mm2 SBS75 - MOQ 100 pcs	7,50
1340G1	Contacto Pre-Mate 16mm2 SBS75X - MOQ 100 pcs	8,60

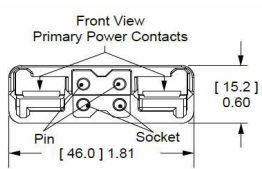

Contactos auxiliares Macho		
PM16P12S30	Contacto Macho 2,5mm2 - MOQ 50 pcs	4,70
PM16P1416S30	Contacto Macho 1 a 1,5mm2 - MOQ 50 pcs	4,30
PM16P1620S30	Contacto Macho 0,75 a 1mm2 - MOQ 50 pcs	4,30
PM16P2024S30	Contacto Macho 0,5 a 0,75mm2 - MOQ 50 pcs	4,30
Contactos auxiliares Hembra		
PM16S12S32	Contacto Hembra 2,5mm2 - MOQ 50 pcs	4,30
PM16S1416S32	Contacto Hembra 1 a 1,5mm2 - MOQ 50 pcs	4,30
PM16S1620S32	Contacto Hembra 0,75 a 1mm2 - MOQ 50 pcs	4,30
PM16S2024S32	Contacto Hembra 0,5 a 0,75mm2 - MOQ 50 pcs	4,30
Conector PCB completo: bipolar + 4 auxiliares o tripolar		
SBS75XPRBLK-bk	Conector Negro SBS75X 2+4 contactos - MOQ 100 pcs	50,00
SBS75GPRBLK-bk	Conector Negro SBS75G 3 contactos 110A - MOQ 100 pcs	50,00

Anderson Airmotive Power

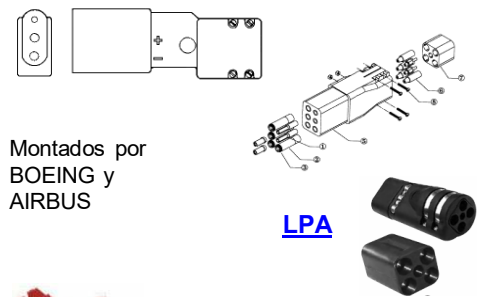

Montados por BOEING y AIRBUS

LPA

Conectores especiales aeronautica (aviones, avionetas, helicópteros) y equipos de pista		P.Netto
R65G5E	MACHO AEREO 28V.DC 3 Polos 2x70mm2	307,00
R65G3E	MACHO AEREO 28V.DC 3 Polos 2x120mm2	307,00
4621B	HEMBRA RECEPTOR 3 POLOS	275,00
R67G36E	CONECTOR AEREO 6 Polos 400Hz 4x50mm2	435,00
R67G5E	CONECTOR AEREO 6 Polos 400Hz 4x70mm2	435,00
TYPE M3/4	CONECTOR AEREO LPA 28V.4x70MM	540,00



Conectores de potencia Unipolares POWERPOLE		P.Netto
PP25 PCB	CONECTOR 25/45A para Circuito Impreso	2,01
PP30	CONECTOR 30A Rojo y Negro Sec.1,3 a 3,3mm ²	1,12
PP30	CONECTOR 30A Verde, Blanco, Azul 1,3 a 3,3mm ²	1,46
PP45	CONECTOR 45A Sec.2,1 a 5,3mm ²	1,46
PP60 PCB	CONECTOR 60A para Circuito Impreso	9,00
PP75	CONECTOR 75A Sec.3,31 a 13,3mm ²	3,30
PP120	CONECTOR 120A Sec.13,3 a 33,6mm ²	7,00
PP180	CONECTOR 180A Sec.21 a 53,5mm ²	10,20

Consultar precios por cantidades

16.- CONECTORES DE POTENCIA UNIPOLARES REMA

2026

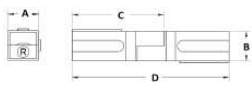
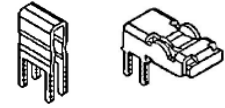
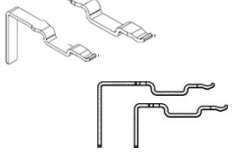
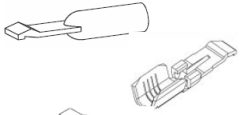
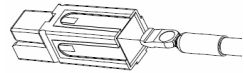
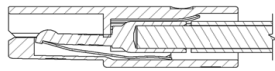

	A	B	C	D
	mm	mm	mm	mm
MC15/30/45	7,9	7,9	24,6	41,3
MC75	15,9	15,9	47,6	81,4
MC120	22,2	22,2	69,9	117,5
MC180	28,6	28,6	82,6	139,7



Ref.	Artículo	1-99	100	500	1000	2500	5000
------	----------	------	-----	-----	------	------	------

Conectores unipolares Monocon 15 a 180A

Carcasas MC15/30/45	80120-00	Carcasa MC15/30/45 ROJA	0,56	0,45	0,39	0,34	0,28	0,25
	80120-01	Carcasa MC15/30/45 NEGRA	0,56	0,45	0,39	0,34	0,28	0,25
	80120-02	Carcasa MC15/30/45 BLANCA	0,90	0,72	0,63	0,54	0,45	0,41
	80120-03	Carcasa MC15/30/45 VERDE	0,90	0,72	0,63	0,54	0,45	0,41
	80120-04	Carcasa MC15/30/45 AZUL	0,56	0,45	0,39	0,34	0,28	0,25
	80120-05	Carcasa MC15/30/45 AMARILLO	0,90	0,72	0,63	0,54	0,45	0,41
Contactos	80120-06	Carcasa MC15/30/45 NARANJA	0,90	0,72	0,63	0,54	0,45	0,41
	80093-01	Contacto MC15 AWG 16 - 1,3mm2	0,56	0,45	0,39	0,34	0,28	0,25
	80093-02	Contacto MC30 AWG 12 - 3,3mm2	0,56	0,45	0,39	0,34	0,28	0,25
Contactos PCB	80093-05	Contacto MC45 AWG 10 - 5,3mm2	0,56	0,45	0,39	0,34	0,28	0,25
	1335G1	PCB 45A Recto 28,5mm	1,45	1,02	0,87	0,73	0,65	0,58
	1336G1	PCB 45A Acodado down 11,9mm	1,45	1,02	0,87	0,73	0,65	0,58
Carcasas MC75	1337G1	PCB 45A Acodado up 19,7mm	1,55	1,09	0,93	0,78	0,70	0,62
	80115-00	Carcasa MC75 ROJA	1,60	1,28	1,12	0,96	0,80	0,72
	80115-01	Carcasa MC75 NEGRA	1,60	1,28	1,12	0,96	0,80	0,72
	80115-03	Carcasa MC75 VERDE	2,40	1,92	1,68	1,44	1,20	1,08
	80115-04	Carcasa MC75 AZUL	1,60	1,28	1,12	0,96	0,80	0,72
Contactos	80115-05	Carcasa MC75 AMARILLA	2,40	1,92	1,68	1,44	1,20	1,08
	78265-05	Contacto MC75 AWG 10 - 5,3mm2	1,70	1,19	1,02	0,85	0,77	0,68
	78265-00	Contacto MC75 AWG 8 - 8,3mm2	1,70	1,19	1,02	0,85	0,77	0,68
Contactos PCB	78265-10	Contacto MC75 AWG 6 - 13,3mm2	1,70	1,19	1,02	0,85	0,77	0,68
	PC5933T	Powerclaw VERTICAL 60A PCB	7,00	4,90	4,20	3,50	3,15	2,80
	PC5934T	Powerclaw HORIZONTAL 60A PCB	7,40	5,18	4,44	3,70	3,33	2,96
Carcasas MC120	PC-HSG-SB	Carcasa NEGRA P-claw Vertical SB	5,00	4,00	3,50	3,00	2,50	2,25
	PC-HSG-PP	Carcasa NEGRA P-claw Vertical PP	4,50	3,60	3,15	2,70	2,25	2,03
Carcasas MC120	80192-00	Carcasa MC120 ROJA	4,20	3,36	2,94	2,52	2,10	1,89
	80192-01	Carcasa MC120 NEGRA	4,20	3,36	2,94	2,52	2,10	1,89
	80192-03	Carcasa MC120 VERDE	6,00	4,80	4,20	3,60	3,00	2,70
	80192-04	Carcasa MC120 AZUL	4,80	3,84	3,36	2,88	2,40	2,16
Contacto	80093-03	Contacto MC120 AWG 2 - 33,6mm2	2,80	1,96	1,68	1,40	1,26	1,12
Carcasas MC180	80193-00	Carcasa MC180 ROJA	6,00	4,80	4,20	3,60	3,00	2,70
	80193-01	Carcasa MC180 NEGRA	6,00	4,80	4,20	3,60	3,00	2,70
	80193-03	Carcasa MC180 VERDE	8,40	6,72	5,88	5,04	4,20	3,78
	80193-04	Carcasa MC180 AZUL	6,50	5,20	4,55	3,90	3,25	2,93
Contactos	78268-00	Contacto MC180 AWG 4 - 21mm2	5,50	3,85	3,30	2,75	2,48	2,20
	78270-01	Contacto MC180 AWG 2 - 33,6mm2	3,30	2,31	1,98	1,65	1,49	1,32
	78270-00	Contacto MC180 AWG 1/0 - 53,5mm2	3,30	2,31	1,98	1,65	1,49	1,32

Agarracables	78000-30	Soporte agarracable con brida MC15/30/45	0,90
	78000-40	Soporte agarracable con brida MC75	1,20
	78000-50	Soporte agarracable con brida MC120	1,50
	78000-60	Soporte agarracable con brida MC180	1,80

Paros de emergencia

80221-00	Seta Roja Paros Emergencia REMA	10,90
80225-00	Paro Emergencia 125A Sin seta	92,70
80225-30	Paro Emergencia 250A Sin seta =80225-31	103,60
80225-20	Paro Emerg. 190A Sin seta +conector negro	103,60
80225-31	Paro Emerg. 190A Sin seta +conector gris	103,60
80227-00	Paro Emerg. 125A+conector Macho DIN 80A	158,10
80260-00	Paro Emerg.RNK 100A pulsador LLAVE	70,80
80261-03	Seta-Llave Roja Paro Emergencia RNK	5,50



Ref.	Artículo	P.V.P.
------	----------	--------

Conectores Euro-DIN 80 (FEM-NF)

108913	95306-00	HEMBRA Sec.16mm sin empuñadura	21,80
108919	95309-00	HEMBRA Sec.25mm sin empuñadura	20,20
108922	95309-10	HEMBRA Sec.35mm sin empuñadura	23,40
108914	95306-01	HEMBRA Sec.16mm + empuñadura fija	23,40
108935	95342-01	HEMBRA Sec.25mm + empuñadura fija	21,80
108920	95309-01	HEMBRA Sec.35mm + empuñadura fija	26,00
	75309-04	HEMBRA Sec.25mm + empuñadura fija ROJO	22,90
108626	95198-00	MACHO Sec.16mm	17,80
108894	95199-00	MACHO Sec.25mm	16,90
108895	95199-10	MACHO Sec.35mm	27,00
	75199-04	MACHO Sec.25mm ROJO	18,00
	77402-00	MACHO Sec.25mm + Curvado 90°	25,10
100441	95244-00	Empuñadura para 80A a presión	4,90
100047	75229-00	Empuñadura ROJA para 80A a presión	6,10
	134G2	Protector contrapolvo MACHO para 95199	8,50

Conectores Euro-DIN 160 (FEM-NF)

108812	95007-01	HEMBRA Sec.25mm + empuñadura fija	30,00
108813	95007-08	HEMBRA Sec.25mm sin empuñadura	28,30
108818	95012-01	HEMBRA Sec.35mm + empuñadura fija	27,80
108819	95012-08	HEMBRA Sec.35mm sin empuñadura	26,20
108826	95017-01	HEMBRA Sec.50mm + empuñadura fija	27,80
108831	95017-08	HEMBRA Sec.50mm sin empuñadura	26,20
108829	95017-05	HEMBRA Sec.70mm + empuñadura fija	44,10
108832	95017-09	HEMBRA Sec.70mm sin empuñadura	42,50
108851	95034-01	MACHO Sec.25mm	24,50
108858	95039-01	MACHO Sec.35mm	23,40
108865	95044-01	MACHO Sec.50mm	23,40
108868	95044-04	MACHO Sec.70mm	34,30
108881	95066-68	Empuñadura para 160A/320A con tornillos	5,20
108906	95239-02	Empuñadura plana 160A con tornillos	6,50
	134G2	Protector contrapolvo HEMBRA para 95017	8,50
	134G3	Protector contrapolvo MACHO para 95044	9,70

Conectores Euro-DIN 320 (FEM-NF)

108972	95601-01	HEMBRA Sec.50mm	34,90
108975	95605-01	HEMBRA Sec.70mm	34,90
108979	95610-01	HEMBRA Sec.95mm	82,00
108952	95500-01	MACHO Sec.50mm	30,50
108957	95505-01	MACHO Sec.70mm	30,50
108960	95510-01	MACHO Sec.95mm	65,40
108881	95066-68	Empuñadura para 160A/320A con tornillos	5,20
	134G3	Protector contrapolvo HEMBRA para 95605	9,70

Tomas de Aire independientes para conectores Euro-DIN

100468	80A.	75070-42 - Toma Aire HEMBRA	14,20
100469		75070-43 - Toma Aire MACHO	14,20
100464	160A.	75070-12 - Toma Aire HEMBRA	14,20
100465		75070-13 - Toma Aire MACHO	14,20
100466	320A.	75070-32 - Toma Aire HEMBRA	14,20
100467		75070-33 - Toma Aire MACHO	14,20

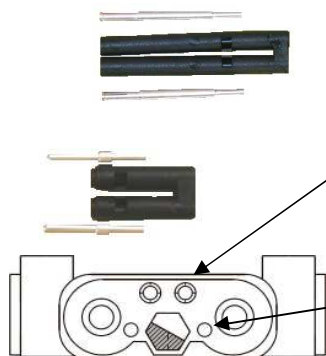

Ref.	Artículo	P.V.P.
Kit de PILOT contacts para DIN (2 contactos + adaptador)		
108657	80A. 75289-00 - Kit Pilot contacts HEMBRA	10,90
108649	80A. 75243-00 - Kit Pilot contacts MACHO	9,80
108609	160A. 75068-03 - Kit Pilot contacts HEMBRA	10,90
108610	160A. 75070-03 - Kit Pilot contacts MACHO	9,80
108749	320A. 75591-00 - Kit Pilot contacts HEMBRA	12,00
108751	320A. 75596-00 - Kit Pilot contacts MACHO	9,80
Contacto AUXILIAR para conectores DIN (por unidad)		
102663	80A. 75240-02 - Contacto Auxiliar HEMBRA	5,50
102641	80A. 75070-02 - 102641 - Contacto Auxiliar MACHO	4,90
115724	160A. 77640-00 - Contacto Auxiliar HEMBRA	10,90
102641	160A. 75070-02 - Contacto Auxiliar MACHO	4,90
	320A. 75590-02 - Contacto Auxiliar HEMBRA	5,50
	320A. 75595-01 - Contacto Auxiliar MACHO	4,90

Contacto HEMBRA



DIN 80A

Contactos de potencia Euro-DIN (FEM-NF) - por unidad			
108691	75317-00	HEMBRA Sec.16mm	7,60
108693	75318-00	HEMBRA Sec.25mm	7,60
108695	75319-00	HEMBRA Sec.35mm	9,30
108681	75314-00	MACHO Sec.16mm	5,50
108687	75315-00	MACHO Sec.25mm	5,50
108689	75316-00	MACHO Sec.35mm	7,60
108544	75022-01	HEMBRA Sec.25mm	11,20
108546	75023-01	HEMBRA Sec.35mm	10,40
108548	75024-01	HEMBRA Sec.50mm	10,40
DIN 160A	108549	75024-05 HEMBRA Sec.70mm	17,40
	108587	75049-01 MACHO Sec.25mm	8,20
	108589	75050-01 MACHO Sec.35mm	8,20
	108591	75051-01 MACHO Sec.50mm	8,20
	108592	75051-05 MACHO Sec.70mm	10,60
	108772	75660-01 HEMBRA Sec.50mm	14,20
	108775	75665-01 HEMBRA Sec.70mm	14,20
DIN 320A	108780	75670-01 HEMBRA Sec.95mm	29,40
	108739	75560-01 MACHO Sec.50mm	11,40
	108743	75565-01 MACHO Sec.70mm	11,40
	111105	75570-01 MACHO Sec.95mm	30,50



DIN 160A

DIN 320A

Contacto MACHO

Conectores FT80 (MIC)



109102	81200-00	HEMBRA Sec. 16mm	17,00
109103	81201-00	HEMBRA Sec.25mm	22,00
109111	81220-00	MACHO Sec.16mm	15,00
109112	81221-00	MACHO Sec.25mm	19,50
109124	81235-00	Empuñadura ROJA FT80	5,20
103149	81243-00	Contacto auxiliar HEMBRA - 1 unidad	10,60
103150	81245-00	Contacto auxiliar MACHO - 1 unidad	4,40

Conectores Twin&Plug (RN-RI 200) Sec.cable 50mm



107333	77351-00	BASE MACHO + Contactos Macho	85,00
107306	76351-00	BASE MACHO + Contactos Hembra	79,60
107338	77461-00	CARGADOR alargado +Contactos Macho	70,90
107308	76470-00	CARGADOR alargado +Contactos Hembra	70,90
107302	76251-00	HEMBRA CON ASA + Contactos Macho	61,00
107331	77251-00	HEMBRA CON ASA + Contactos Hembra	85,00
107317	76766-00	CONTACTO MACHO 200A 50MM	27,30
107325	76916-00	CONTACTO HEMBRA 200A 50MM	27,30

Conectores RA 150

75140-00	HEMBRA Sec.25mm	31,50
75141-00	MACHO Sec.25mm	27,50



terminal ojo



terminal FLEX



terminal batería



terminal PERFECT



Macho



Hembra

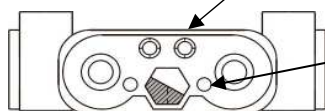

Ref.	Artículo	P.V.P.
Linde.ref. Conectores MRC especiales LINDE		
3863811512	M80807-00 MRC250A 24V Hembra 50mm2 +113/-153cm, pin rojo, asa, terminal ojo	169,00
3863811518	M80807-60 MRC250A 24V Hembra 50mm2 +109/-149cm, pin rojo, asa, terminal FLEX	169,00
3863811513	M80807-10 MRC250A 48V Hembra 50mm2 +153/-113cm, pin rojo, asa, terminal ojo	169,00
3873811503	M80807-72 MRC250A 80V Hembra 50mm2 +153/-113cm, pin rojo, asa, terminal FLEX	169,00
	M80807-73 MRC250A 80V Hembra 50mm2 +153/-113cm, pin rojo, asa, Toma Aire, terminal FLEX	169,00
3863812007	M80837-40 MRC250A 48V Macho 50mm2 +112/-58,5cm, pin rojo, asa, terminal ojo	162,00
3873811508	M80809-72 MRC320A 80V Hembra 70mm2 +146/-106cm, pin gris, asa, terminal FLEX	245,00
3873811508	M81009-91 MRC320A 80V Hembra 50cm2 +150/-120cm, pin gris, asa, terminal FLEX	250,00

Pin ROJO especial para alto amperage MRC

MRC120	111344 = 75435-75 - Pin ROJO HEMBRA	10,90
	111343 = 75435-70 - Pin ROJO MACHO	10,90
MRC260	109630 = 75057-75 - Pin ROJO HEMBRA	10,90
	111372 = 75057-70 - Pin ROJO MACHO	10,90
MRC400	109632 = 75057-85 - Pin ROJO HEMBRA	10,90
	109631 = 75057-80 - Pin ROJO MACHO	10,90

Kit de PILOT contacts para MRC (2 contactos + adaptador)

80A.	M93080-73 - Kit Pilot contacts HEMBRA	18,50
	M93080-43 - Kit Pilot contacts MACHO	16,40
160A.	M93160-73 - Kit Pilot contacts HEMBRA	19,60
	M93160-43 - Kit Pilot contacts MACHO	17,40
320A.	110169 = M93320-73 - Kit Pilot contacts HEMBRA	19,60
	110160 = M93320-43 - Kit Pilot contacts MACHO	19,60

Contacto AUXILIAR para conectores MRC (por unidad)

80A.	103741 = M93080-72 - Contacto Auxiliar HEMBRA 1,5mm	6,00
	111104 = M93080-22 - Contacto Auxiliar MACHO 1,5mm	5,20
160A.	103743 = M93160-71 - Contacto Auxiliar HEMBRA 1,5mm	6,50
	103742 = M93160-21 - Contacto Auxiliar MACHO 1,5mm	5,70
320A.	103747 = M93320-71 - Contacto Auxiliar HEMBRA 1,5mm	7,10
	103745 = M93320-21 - Contacto Auxiliar MACHO 1,5mm	6,30

Conectores MRC especiales STILL

Still 50024244029	M80907-32 MRC80A 24V Hembra 50mm2 +100/-100cm, pin amarillo, terminal ojo	105,00
Still 50024244030	M80907-87 MRC80A 24V Macho 50mm2 +100/-100cm, pin amarillo, terminal ojo	103,00

Flame proof connector

EN 50014 & 50019, 250V, 250A



Conectores DR E250 Eex II ANTIDFLAGANTE

Estandar para secciones 25-50mm² y 70mm²

79250-00	CONECTOR DR E250 ex MACHO 50mm ² (+)	339,00
79250-01	CONECTOR DR E250 ex MACHO 50mm ² (-)	339,00
79270-00	CONECTOR DR E250 ex MACHO 70mm ² (+)	339,00
79270-01	CONECTOR DR E250 ex MACHO 70mm ² (-)	339,00
79350-00	CONECTOR DR E250 ex HEMBRA PANEL M12	285,60

Versión con pin central para secciones 25-50mm² y 70mm²

79250-05	CONECTOR DR E250 ex MACHO 50mm ² (+)	371,70
79250-06	CONECTOR DR E250 ex MACHO 50mm ² (-)	371,70
79270-05	CONECTOR DR E250 ex MACHO 70mm ² (+)	371,70
79270-06	CONECTOR DR E250 ex MACHO 70mm ² (-)	371,70
79350-05	CONECTOR DR E250 ex HEMBRA PANEL M12	357,50
79390-00	Kit instalación DR E250 ex HEMBRA PANEL	76,30

Conectores Euro-DIN 640 (FEM-NF)

108996	95950-00	HEMBRA 640A Sec.240mm	250,70
111163	95950-10	HEMBRA 640A Sec.120mm	250,70
111164	95950-20	HEMBRA 640A Sec.95mm	250,70
111165	95950-30	HEMBRA 640A Sec.70mm	250,70
108995	95850-00	MACHO 640A Sec.240mm	348,80
111160	95850-10	MACHO 640A Sec.120mm	348,80
111161	95850-20	MACHO 640A Sec.95mm	348,80
111162	95850-30	MACHO 640A Sec.70mm	348,80
108994	95800-11	Empuñadura con 4 tornillos 640A	9,80
	71823-00	Reductor 240mm a 120mm DIN640 (1 unidad)	33,80
	71825-00	Reductor 240mm a 185mm DIN640 (1 unidad)	43,60

Timones

		P.Neto
84610-20	funciones: 1 mando mariposa, potenciómetro, 4 microruptores ON/OFF, 1 interruptor de seguridad y llave de contacto - color VERDE	295,00
84610-50	funciones: 1 mando mariposa, potenciómetro, 4 microruptores ON/OFF, 1 interruptor de seguridad y llave de contacto - color GRIS	295,00
69430-14	funciones: 1 mando mariposa, potenciómetro, 2 rockerSwitch ON/OFF, 1 interruptor de seguridad y llave de contacto - color VERDE	325,00
69430-xx	funciones: 1 mando mariposa, potenciómetro, 2 rockerSwitch ON/OFF, 1 interruptor de seguridad y llave de contacto - color GRIS	325,00

Set Herramientas de encastre: herramienta + 10 dados de 10 a 95mm + caja transporte P.Neto

56942-00	MPD-RMC 15/75 de 1,5mm a 16mm	125,00
55800-xx	Set MP60: herramienta MANUAL	900,00
57006-xx	Set HP60H: herramienta HIDRAULICA	1.200,00



Ref.	Artículo	P.V.P.
Sensor de Nivel de Electrolito para baterías de plomo abierto con electrolito líquido		
ACC-BWM-B	Blinky largo 102mm Conexión por tornillo. Led verde: nivel correcto - Led apagado: falta agua	22,00
ACC-SWM-B	SmartBlinky largo 102mm Conexión por tornillo. Led verde: nivel correcto - Led Rojo: falta agua	38,00
ACC-SREM-B	Smart Blinky largo 102mm Conexión por tornillo. LED remoto en cajita negra	48,00
ACC-SWM-BR	Smart Blinky largo 102mm Conexión por tornillo. LED remoto 2m para integrar en tablero	46,00
ACC-SWM-BRC	Smart Blinky largo 102mm Conexión por tornillo. LED remoto 2m integrado en agarracables	48,00
ACC-SWP-C	Smart Blinky Pro Alarma + LED, remoto 2m integrado en cables y conector	55,00
ACC-SWP-Q	Smart Blinky Pro Alarma + LED, sobre batería Quick Tap	69,00
ACC-SWP-QX	Smart Blinky Pro Alarma + LED, blackbox externo a batería Quick Tap	70,00
ACC-SWM-QR6V	Smart Blinky Baterías Monobloc 6V. Led remoto 2m. 2x pincha cable	48,00
ACC-SWM-IF	Smart Blinky Interface con salida "clean contact" para dar señal a otro equipo. 2m de cable	90,00

Voltaje de trabajo: 4.0V Blinky

4.0V a 12.0V Smart Blinky

6.0V Smart Blinky Monobloc

24V a 80V Smart Blinky Pro

Corriente nominal: 60mA Blinky - 2,67mA Smart Blinky

Nivel de medida de electrolito: 25mm-125mm

Protecciones: interna - fusible 125ma

externa - fusible 125ma en cable Negativo

Temperatura de trabajo: 0 a 70°

Sensor de líquido en cofre de batería

para prevenir corrosión y deterioro del cofre



ACC-STM-B	Sensor de líquido en cofre 6-12V M10 Bolt-on	49,00
ACC-STM-Q	Sensor de líquido en cofre 6-12V FlexiTap	49,00
ACC-STM-S	Sensor de líquido en cofre 6-12V M4 Screw-on	45,00



eGO historial, control y gestión de baterías

eGOC y eGOL para monitorizar el histórico de las baterías

	EGOC-12SE	Monitorizador Batería Plomo M4 Bluetooth	201,00
	EGOC-12QE	Monitorizador Batería Plomo FlexiTap Bluetooth	208,00
	EGOC-12SG	Monitorizador Batería GEL M4 Bluetooth	198,00
	EGOC-12QG	Monitorizador Batería GEL FlexiTap Bluetooth	205,00
	EGOL-12QE	Monitorizador Batería 12V Plomo FT USB	285,00
	EGOL-12QG	Monitorizador Batería 12V GEL FT USB	291,00
	EGOL-24QE	Monitorizador Batería 24-80V Plomo FT USB	285,00
	EGOL-24QG	Monitorizador Batería 24-80V GEL FT USB	291,00
	EGOL-24SE	Monitorizador Batería 24-80V Plomo M4 USB	280,00
	EGOL-24SG	Monitorizador Batería 24-80V GEL M4 USB	286,00

eGO PRO historial, control y gestión de baterías

eGO PRO Monitorizado completo

eGOP-A24QE600AA	Monitorizador PRO 24-80V Plomo M4 Sensor Hall para medir corrientes	420,00
eGOP-A72QE600AA	Monitorizador PRO 72V Plomo M4 Sensor Hall para medir corrientes	420,00
eGOP-A24QG600AA	Monitorizador PRO 24-80V VRLA M4 Sensor Hall para medir corrientes	395,00
IHUB-CL2	Cloud Link eGO Data Hub WiFi w/o Power Cable	725,00
IHUB-CLSE1	Cloud Link Short Range V1.0	495,00
IHUB-EGO-RK	Receptor PC para eGO Bluetooth	270,00
iHUB-ROU	Router, receptor y transmisor para eGO (no incluye targeta SIM)	1.275,00
iHUB-ROU1	iHUB protegido IP65 (no incluye targeta SIM)	1.540,00
IHUB-sim	Tarjeta SIM - según ubicación proyecto	0,00

ELECTROLYTE LEVELS

Our eGO! products feature our industry standard SmartBlinky Technology alerting you when the battery needs water.

NORMAL CYCLES

When a battery is charged, used and discharged, this is classed as a normal usage cycle.

WORK TIME

You can see exactly how long each battery has worked for, helping you to streamline assets.

COOL DOWN TIME

Using a battery that hasn't cooled down enough drastically impacts performance, we track it so you can change practices.

BI-DIRECTIONAL ENERGY

Bi-directional energy monitoring shows how much energy has gone into and out of the battery.

TEMPERATURE LEVELS

Hot running or charging temperatures are a telltale sign that something is wrong. Our eGO! will alert you to it.

OPPORTUNITY CYCLES

If a battery is charged multiple times during a work cycle this reduces overall life expectancy.

REST TIME

Reporting in conjunction with Work Time, this shows how long a battery has stood unused with charge.

LIFE USED

Calculating the lifespan of a battery using the data captured through the eGO! we can show current life used.

DATA RECEIVED

If we don't get the data you don't get the information. We can track exactly when we last received an upload online.

ABUSE CYCLES

Abuse cycles are another big killer of batteries. We track it so you can amend working practices and maintenance.

CHARGE TIME

The amount of time a battery has been on charge can indicate a whole range of issues with capacity.

LIFE REMAINING

Working in with Life Used, life remaining allows you to effectively plan in replacing batteries and assets.

LIFETIME ENERGY THROUGHPUT

Working in conjunction with the bi-directional energy metric you can see total energy throughput for the battery.



Flotas Grandes

TANQUES DE RELLENO A PRESIÓN POR INYECTORES para rellenados de baterías provistas de sistema de inyectores

INJ-ESUBCOMPeu	HYDROJET Compact 32 litros, cable sector 230vac	760,00
INJ-ESUB420U	HYDROJET 80 litros, cable sector 230vac	1.565,00

Repuestos y accesorios

INJ-607	Válvula rápida PRO +Flow Indicator (=INJ-126+INJ-553)	99,00
INJ-E076	Bomba HydroCart Mini 230V c/w Transition Fitting	644,00
INJ-E038	Bomba HydroCart 80l. 230V c/w Transition Fitting	635,00
INJ-E077	Manguera HydroCart Mini	55,00
INJ-E032	Manguera HydroCart 80l azul	61,00

WATERINJECTOR o AQUAJET

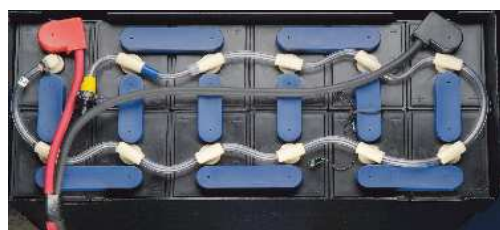

Presión de trabajo: 25-35psi (1,7-2,4 bar)

Tiempo de llenado por batería: 15 segundos

INJ-S6ED	6 Cell Injector String, DIN Adaptors Fitted	84,00
INJ-S12ED	12 Cell Injector String, DIN Adaptors Fitted	139,00
INJ-S18ED	18 Cell Injector String, DIN Adaptors Fitted	198,00
INJ-S20ED	20 Cell Injector String, DIN Adaptors Fitted	218,00
INJ-S24ED	24 Cell Injector String, DIN Adaptors Fitted	259,00

Repuestos y accesorios

INJ-311	Toolkit, Cortador tubo Inyectores	238,00
INJ-L1	Inyector simple	11,00
INJ-522	Inyector valvula Final	15,50
INJ-CP	Enchufe rápido Macho para Inyectores	6,80
INJ-465	Unión para reparación Inyectores, pack 12 units	36,90
INJ-212	Brida para Inyectores, pack 25 units	19,80
INJ-198	Tubo Inyectores Type 2 <12 elem. x1 metro	4,20
INJ-199	Tubo Inyectores Type 3 >12 elem. x1 metro	4,20

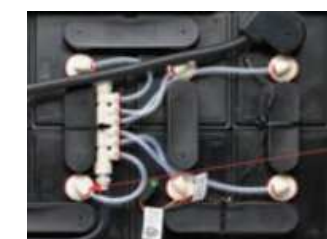

SPIDER system

Presión de trabajo: 25-35psi (1,7-2,4 bar)

Tiempo de llenado por batería: 15 segundos

INJ-LP6ED	Inyectores Spider 6 celdas 12V tipo DIN	92,00
INJ-LP12ED	Inyectores Spider 12 celdas 24V tipo DIN	161,00
INJ-LP18ED	Inyectores Spider 18 celdas 36V tipo DIN	231,00
INJ-LP20ED	Inyectores Spider 20 celdas 40V tipo DIN	253,00
INJ-LP24ED	Inyectores Spider 24 celdas 48V tipo DIN	293,00



Flotas Pequeñas y Medianas - Ibos Lite

Sistema Inteligente de Organización de Baterías de un mismo tipo

BOS-CB6400EL	Controlador iBOS Lite hasta 50 cargadores, 1 tipo	1.250,00
BOS-226	iBOS Sentinel Cable Lead RJ12 L=1.0m/3ft	19,00
BOS-228	iBOS Sentinel Cable Lead RJ12 L=2.0m/7ft	22,00
BOS-229	iBOS Sentinel Cable Lead RJ12 L=3.0m/10ft	28,00
BOS-SU6000R	Centinela iBOS Blue (Plus & Pro)	250,00



Flotas Pequeñas y Medianas - Ibos Basic

Sistema Inteligente de Organización de Baterías de un mismo tipo

BOS-CB6400EL	Controlador iBOS Basic 50 cargadores + alarma	1.250,00
BOS-SU6000R	Centinela iBOS Blue (Plus & Pro)	250,00



Flotas Medianas y Grandes - iBOS Plus

Sistema Inteligente de Organización de Baterías

Hasta 100 cargadores y 9 tipos de batería, alarma incorporada

Información e historial en pantalla táctil

BOS-CB6500EU0	Controlador iBOS-Plus 100 cargadores, 9 tipos	5.665,00
BOS-SU6000R	Centinela iBOS Lite Blue (Plus & Pro)	250,00
BOS-INSTALL	Instalación, precio por cargador. Mínimo 30 units	124,00



Flotas Medianas y Grandes - iBOS Plus & Pro web report

Sistema Inteligente de Organización de Baterías online

Nºilimitado de baterías y tipos de batería, control vía email

Control en web, avisos en tiempo real, rappsorts y gráficos

BOS-CB6500EU	Controlador iBOSPlus 100 cargadores, 9 tipos, web	5.500,00
BOS-CB6700EU	Controlador iBOSPro 200 cargadores, 9 tipos, web	9.675,00
BOS-CB6710EU	Controlador iBOSPro Ext. 350 cargadores, 9 tipos, web	16.060,00
BOS-SU6000R	Centinela iBOS Plus & Pro Blue, web reporting	250,00
BOS-INSTALL	Instalación, precio por cargador. Mínimo 30 units	124,00
BOS-WS	Suscripción anual iBOSworld website (Coste fijo)	365,00
iHUB-ROU1	iBOS Router c/w 1x Wi-Fi 2x Antenna Ext SIM Conn Encl IP65	650,00
iHUB-SIM	iBOS targeta SIM	45,00

Opciones adicionales:

BOS-HDS6N	iBOS PLUS HD Driver para TV externo	830,00
BOS-DSPT	Display alargado tricolor. Scrolling	1.165,00
BOS-SH6000	Alarma externa "Tomas Erroneas"	820,00
BOS-DCBL	Cable para transmisión de datos (rollo 500m)	900,00



Cómo funciona iBOS

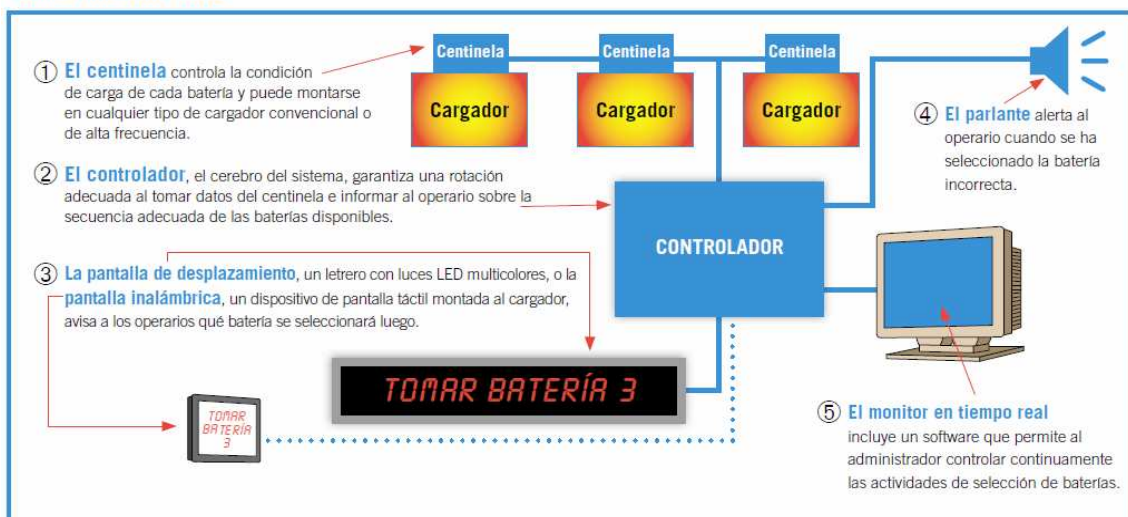



Equipo de Desionización de Agua

para transformar agua del grifo en agua pura ideal para baterías

PS-300	Desionizador completo, para aprox 2400 litros con indicador de nivel de pureza y baterías	445,00
PS-400	Doble Desionizador, para aprox 4800 litros con indicador de nivel de pureza y baterías	1.210,00
PS-600	Cartucho capacidad aprox 2400 Litros	185,00



Flotas Pequeñas y Medianas

CARROS DE RELLENO A BAJA PRESIÓN

para llenado manual a pistola y automático con Stealth/BFS/Frotec

CRT-2A2EU	HYDROFILL Carro movil 30ltr, con batería, bomba y cargador 12V	748,00
CRT-2A2EUG	HYDROFILL Carro movil 30ltr, con batería, bomba y cargador 12V, y pistola B	825,00
GUN-X	Pistola boquilla 17mm, antigoteo, flow indicator	88,00
GUN-S	Pistola especial baterías estacionarias	88,00



Flotas Pequeñas y Medianas

CARROS DE RELLENO A BAJA PRESIÓN

para llenado manual a pistola y automático con Stealth/BFS/Frotec

CRT-32	HYDROFILL Carro movil 60ltr, con batería, bomba y cargador 12V, y display informativo	770,00
CRT-E210	Adaptador pistola GUN-X	28,00
CRT-E208	Temporizador con reductor de caudal	137,00
CRT-E209	Reductor de caudal	44,00
GUN-X	Pistola boquilla 17mm, antigoteo, flow indicator	88,00
PS-600	Cartucho capacidad aprox 2400 Litros	185,00

Ref.	Artículo	P.V.P.
------	----------	--------

Tapón BFS A51000

(pedido mínimo 400 unidades)
1 pallet = 9600 tapones

A51000	Tapón a presión	6,00
	1 pallet = 9600 tapones	4,00



Boyas BFS

(pedido mínimo 400 unidades)

072220	Boya 47/34 Ø22mm H.20mm	1,00
072224	Boya 51/39 Ø22mm H.24mm	1,00
072229	Boya 56/42 Ø22mm H.29mm	1,00
072234	Boya 61/46 Ø22mm H.34mm	1,00
072239	Boya 66/50 Ø22mm H.39mm	1,00
072244	Boya 71/56 Ø22mm H.44mm	1,00
072249	Boya 76/57 Ø22mm H.349m	1,00

15.- PROTECTORES PARA BORNES DE POTENCIA VTE

2025

Secciones de entrada de cable

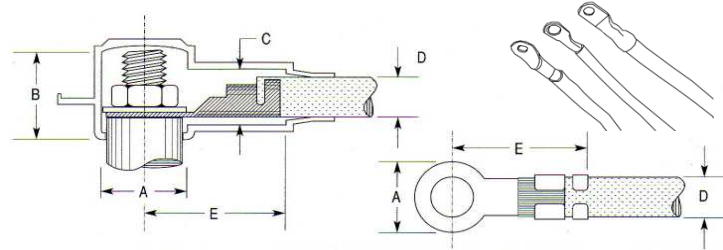
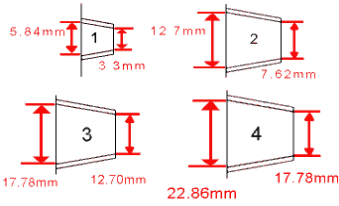

Ref.	A	B	C	D	E	1-99	100	500	1.000
212N	12	17,8	12,7	1-2	25,4	0,85	0,56	0,47	0,38
214N	14	19,1	12,7	1-2	25,4	1,09	0,73	0,60	0,49
216N	16	20,3	12,7	1-2	25,4	1,34	0,89	0,74	0,60
218N	18	22,1	12,7	1-2	25,4	1,60	1,07	0,88	0,72
220N	60	21,3	17,8	1-2-3	33,5	1,84	1,23	1,01	0,83
222N	22	26,7	17,8	1-2-3	33,5	2,08	1,39	1,15	0,94
224N	24	28,7	17,8	1-2-3	41,1	2,34	1,56	1,28	1,05
226N	26	31,8	17,8	1-2-3	41,1	2,59	1,72	1,42	1,16
228N	28	33,5	19,1	1-2-3	44,5	2,84	1,89	1,56	1,28
230N	30	35,6	19,1	1-2-3	44,5	3,09	2,06	1,70	1,39
232N	32	38,1	22,9	1-2-3-4	44,5	3,32	2,21	1,83	1,49
234N	34	40,6	22,9	1-2-3-4	50,8	3,58	2,39	1,97	1,61



Cubre bornes frontales rectos de diferentes formatos

Ø borne + Ø cable

800N4Vxx	Ø18,5 Cable Ø4,3mm	6,30	4,20	3,46	2,83
800N5Vxx	Ø18,5 Cable Ø5,3mm	1,55	1,03	0,85	0,70
800N8Vxx	Ø18,5 Cable Ø7,9mm	1,55	1,03	0,85	0,70
800N9Vxx	Ø18,5 Cable Ø12,7mm	1,55	1,03	0,85	0,70
801N8V02	Ø19,1 rojo, cable Ø7,9	1,49	0,99	0,82	0,67
801N8V14	Ø19,1 negro, cable Ø7,9	1,49	0,99	0,82	0,67
490N9V02	Ø19,1 - cable Ø12,7	1,14	0,76	0,63	0,52
490N9V14	Ø19,1 - cable Ø12,7	1,14	0,76	0,63	0,52
470N9V02	Ø21,6 rojo, cable Ø15,9	2,28	1,52	1,25	1,03
470N9V14	Ø21,6 negro, cable Ø15,9	2,28	1,52	1,25	1,03
405N1Vxx	Ø25,4 - cable Ø3,3mm	1,37	0,92	0,76	0,62
405N2Vxx	Ø25,4 - cable Ø7,6mm	1,37	0,92	0,76	0,62
405N9Vxx	Ø25,4 - cable Ø12,7mm	1,37	0,92	0,76	0,62
487N6Vxx	Ø32 Cable Ø12,7mm	2,75	1,83	1,51	1,24
487N7Vxx	Ø32 Cable Ø15,2mm	2,63	1,76	1,45	1,18
487N8Vxx	Ø32 Cable Ø16,5mm	2,63	1,76	1,45	1,18
487N9Vxx	Ø32 Cable Ø19mm	2,63	1,76	1,45	1,18

15.- PROTECTORES PARA TERMINALES DE BATERÍA VTE

2025

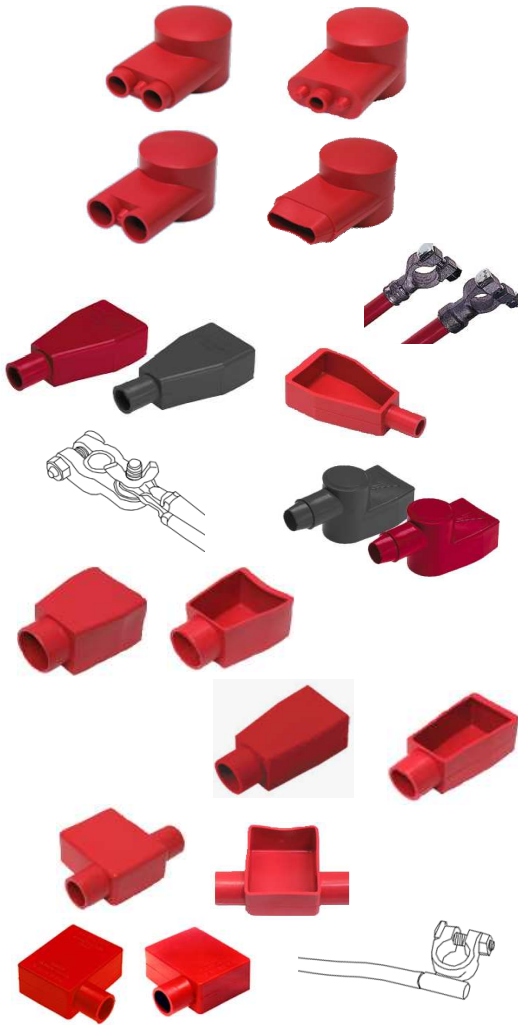

Ref.	Artículo	1-99	100+	500+	1000+
Cubre bornes conexiones múltiples, borne Ø40mm					
600N1Vxx	Ø40, cable Ø7,9mm	2,63	1,76	1,45	1,18
600N2Vxx	Ø40, 2 cables Ø7,9mm	2,63	1,76	1,45	1,18
600N3Vxx	Ø40, cable Ø12,7mm	2,86	1,91	1,57	1,29
600N4Vxx	Ø40, 2 cables Ø12,7mm	2,63	1,76	1,45	1,18
600N5Vxx	Ø40, cable Ø15,8mm	2,86	1,91	1,57	1,29
600N6Vxx	Ø40, 2 cables Ø15,8mm	3,21	2,14	1,76	1,44
600N7Vxx	Ø40, cable oval 31,6x8mm	2,86	1,91	1,57	1,29
Cubre bornes conexión frontal recta 59,5x35,5mm alto 19mm					
415N6Vxx	cable Ø9,5mm	1,89	1,26	1,04	0,85
415N7Vxx	cable Ø11mm	1,95	1,30	1,07	0,88
415N8Vxx	cable Ø12,7mm	1,89	1,26	1,04	0,85
415N9Vxx	cable Ø12,7mm	1,95	1,30	1,07	0,88
415N0Vxx	cable Ø19mm	1,89	1,26	1,04	0,85
Cubre bornes conexión frontal recta alta					
457N1Vxx	Ø30,5 - cable Ø3-8mm	3,38	2,25	1,86	1,52
457N2Vxx	Ø30,5 - cable Ø8-13,5mm	3,38	2,25	1,86	1,52
457N3Vxx	Ø30,5 - cable Ø14-19mm	3,66	2,44	2,01	1,65
Cubre bornes salida frontal 55x82mm alto 41mm					
973N8V14	cable Ø30,5mm	7,10	4,73	3,90	3,19
973N8V02	cable Ø30,5mm	7,10	4,73	3,90	3,19
Cubre bornes salida frontal 61x82mm alto 30,5mm					
974N9V14	cable Ø20mm	5,38	3,59	2,96	2,42
974N9V02	cable Ø20mm	5,38	3,59	2,96	2,42
Cubre bornes doble salida lateral 65x50mm alto 30mm					
975D8V14	cable Ø20mm	10,30	6,87	5,67	4,64
975D8V02	cable Ø20mm	10,30	6,87	5,67	4,64
Cubre bornes salida lateral, 61x47mm alto 24,9mm					
500L9V14	Left Negro, Ø17,5mm	4,80	3,20	2,64	2,16
500R9V02	Right Rojo, Ø17,5mm	4,80	3,20	2,64	2,16
Cubre bornes salida lateral, 63x46mm alto 25,65mm + ojillo brida					
900L9V14	Left Negro, Ø17,5mm	4,45	2,97	2,45	2,00
900R9V02	Right Rojo, Ø17,5mm	4,45	2,97	2,45	2,00

Modelos Protectores de entrada a presión, por clip, extraible sin desconectar

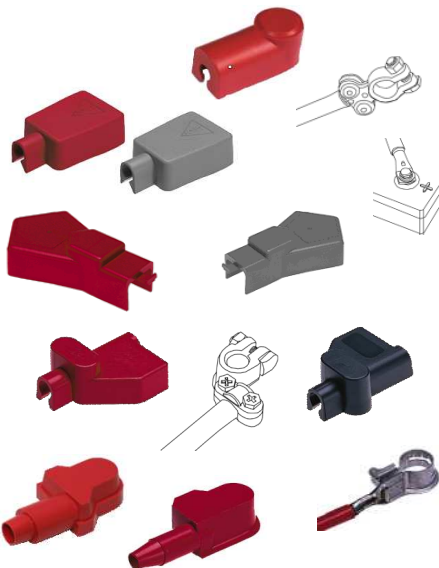

Para terminales de batería de conexión frontal recta					
216T8V14	Ø16,3 - cable Ø6,9mm	5,72	3,82	3,15	2,58
216T8V14	Ø16,3 - cable Ø6,9mm	5,72	3,82	3,15	2,58
417N9V14	58x43mm, cable Ø12,7	5,38	3,59	2,96	2,42
417N9V02	58x43mm, cable Ø12,7	5,38	3,59	2,96	2,42
436N7V02	68x53mm, cable Ø16,3	2,86	1,91	1,57	1,29
436N7V14	68x53mm, cable Ø16,3	2,86	1,91	1,57	1,29
<i>existe en entrada N4 Ø9,14mm y N5 Ø12,2mm - mismo precio</i>					
436S5V02	68x53mm, cable Ø12,2 corto	2,40	1,60	1,32	1,08
436S5V14	68x53mm, cable Ø12,2 corto	2,40	1,60	1,32	1,08
Para terminales de batería de conexión lateral					
453L9V14	Left Negro (-) Ø12,7mm	4,81	3,21	2,64	2,16
454R9V02	Right Rojo (+) Ø12,7mm	4,81	3,21	2,64	2,16
409N3V02	50x45mm, cable Ø12,8	2,29	1,53	1,26	1,03
409N3V14	50x45mm, cable Ø12,8	2,29	1,53	1,26	1,03
409N9V02	50x20mm, cable Ø7,6	4,01	2,67	2,20	1,80
409N9V14	50x20mm, cable Ø7,6	4,01	2,67	2,20	1,80



Ref.	Artículo	1-24	25+	100+	500+
Distribuidor de potencia 160A base pequeña					
Borne de #10-5mm, 1/4" -6,3mm, 5/16" -8mm, 3/8" -10mm					
77010N02	#10 / 5mm Rojo	7,42	5,57	4,45	3,34
77010N14	#10 / 5mm Negro	7,42	5,57	4,45	3,34
77025N02	1/4" / 6,35mm Rojo	8,27	6,20	4,96	3,72
77025N14	1/4" / 6,35mm Negro	8,27	6,20	4,96	3,72
77008N02	M8 Rojo	6,68	5,01	4,01	3,01
77008N14	M8 Negro	6,68	5,01	4,01	3,01
77037N02	3/8" / 10mm Rojo	7,95	5,96	4,77	3,58
77037N14	3/8" / 10mm Negro	7,95	5,96	4,77	3,58
Soporte y separador para dos distribuidores					
72770000	6,7x6,7cm + separador alto 5,7cm	9,65	7,23	5,79	4,34
Distribuidor de potencia 250A base reforzada					
Borne de M10 - M12 - 1/2"					
77510M0N02	M10 Rojo	11,98	8,98	7,19	5,39
77510M0N14	M10 Negro	11,45	8,59	6,87	5,15
77512M0N02	M12 Rojo	13,14	9,86	7,89	5,91
77512M0N14	M12 Negro	12,61	9,46	7,57	5,68
77512N0N02	1/2" Rojo	13,78	10,34	8,27	6,20
77512N0N14	1/2" Negro	12,83	9,62	7,70	5,77
956D9V02	Protector doble entrada 1,8cm +tapa	6,89	5,17	4,13	3,10
795V02	Protector entrada cable simple y multiples cables + tapa	11,45	8,59	6,87	5,15
Distribuidor de potencia 160A base grande					
Borne de 1/4" -6,3mm, 5/16" -8mm, 3/8" -10mm					
77125N02	1/4" / 6,35mm Rojo	12,61	9,46	7,57	5,68
77125N14	1/4" / 6,35mm Negro	11,98	8,98	7,19	5,39
77131N02	5/16" / 7,9mm Rojo	10,49	7,87	6,30	4,72
77131N14	5/16" / 7,9mm Negro	9,75	7,31	5,85	4,39
77137N02	3/8" / 9,5mm Rojo	11,02	8,27	6,61	4,96
77137N14	3/8" / 9,5mm Negro	10,49	7,87	6,30	4,72
Distribuidor de potencia 160A, a 8 puntos (8x20A)					
Borne de 1/4" -6,3mm, 5/16" -8mm, 3/8" -10mm					
77825N02	1/4" / 6,35mm Rojo	23,43	17,57	14,06	10,54
77825N14	1/4" / 6,35mm Negro	22,68	17,01	13,61	10,21
77831N02	5/16" / 7,9mm Rojo	23,43	17,57	14,06	10,54
77831N14	5/16" / 7,9mm Negro	22,68	17,01	13,61	10,21
77837N02	3/8" / 9,5mm Rojo	23,43	17,57	14,06	10,54
77837N14	3/8" / 9,5mm Negro	22,68	17,01	13,61	10,21
Distribuidor de potencia a 3 puntos					
3 conexiones bus - 700A - Medidas: 121x48x73mm					
7753N7N02	1x 3/8 + 2x 5/16", rojo	74,41	55,81	44,65	33,49
7753N7N02	1x 3/8 + 2x 5/16", negro	74,41	55,81	44,65	33,49
375T5P02	Protector en T rojo	5,72	4,29	3,43	2,58
375T5P14	Protector en T negro	5,72	4,29	3,43	2,58

DISTRIBUIDOR OFICIAL



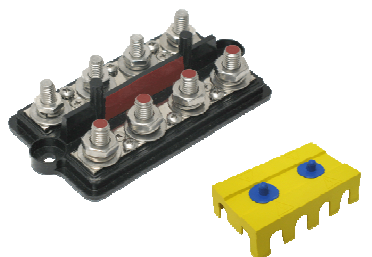
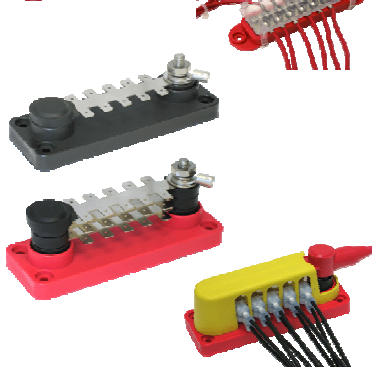
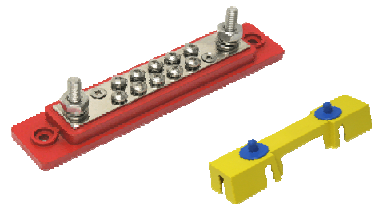
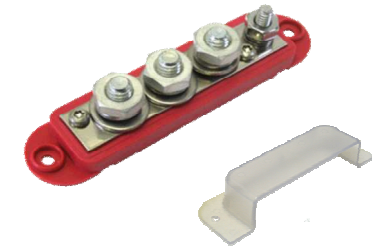

Ref.	Artículo	1-24	25+	100+	500+
Distribuidor de potencia a 4 puntos					
3+1 conexiones bus - 210A - Medidas: 133x29x29mm					
7705N0N02	1x 1/4" 6mm, 3x 5/16" 8mm, rojo	30,95	23,21	18,57	13,93
7705N0N14	1x 1/4" 6mm, 3x 5/16" 8mm, negro	30,95	23,21	18,57	13,93
7704N0N02	1x 1/4" 6mm, 3x 3/8" 10mm, rojo	28,62	21,47	17,17	12,88
7704N0N14	1x 1/4" 6mm, 3x 3/8" 10mm, negro	28,62	21,47	17,17	12,88
314N0P00	Protector bus 4 conexiones	6,89	5,17	4,13	3,10
Distribuidor de potencia 4 puntos largos en 5/16, 3/8, M8, M11					
Permite multiples conexiones por borne					
4 conexiones bus - 250A - Medidas: 168x35x45mm					
74312N0N02	4x 5/16", rojo	31,91	23,93	19,14	14,36
74312N0N14	4x 5/16", negro	31,16	23,37	18,70	14,02
74375N0N02	4x 3/8", rojo	31,91	23,93	19,14	14,36
74375N0N14	4x 3/8", negro	31,16	23,37	18,70	14,02
74008N0N02	4x 8mm, rojo	28,94	21,70	17,36	13,02
74008N0N14	4x 8mm, negro	28,41	21,31	17,04	12,78
74010N0N02	4x 10mm, rojo	31,38	23,53	18,83	14,12
74010N0N14	4x 10mm, negro	30,85	23,13	18,51	13,88
723N2	Tapa 4 conexiones largo Rojo	8,06	6,04	4,83	3,63
723N6	Tapa 4 conexiones largo Negro	8,06	6,04	4,83	3,63
Distribuidor de potencia a 10+2 puntos					
10 conexiones bus (20A) + 2 conexiones Ø6mm, 200A					
771025N0N02	10+2 conexiones bus Ø6mm, rojo	29,57	22,18	17,74	13,31
771025N0N14	10+2 conexiones bus Ø6mm, negro	29,04	21,78	17,43	13,07
724N3P05	Protector amarillo bus de 10+2	9,12	6,84	5,47	4,10
Distribuidor de potencia a 12+1 puntos + tapa + protector					
12 conexiones bus (20A) + 1 conexión Ø6mm, 240A					
71225N02	12+1 conexiones bus Ø6mm, rojo	28,09	21,07	16,85	12,64
71225N14	12+1 conexiones bus Ø6mm, negro	27,45	20,59	16,47	12,35
Distribuidor de potencia con fastón a 10, 20 y 30 puntos					
10/20/30 conexiones faston(20A) con tapa protectora					
TTB710N02	10 conexiones fastón, rojo	30,95	23,21	18,57	13,93
TTB710N14	10 conexiones fastón, negro	29,89	22,42	17,94	13,45
TTB720N02	20 conexiones fastón, rojo	40,70	30,53	24,42	18,32
TTB720N14	20 conexiones fastón, negro	39,75	29,81	23,85	17,89
TTB730N02	30 conexiones fastón, rojo	47,70	35,78	28,62	21,47
TTB730N14	30 conexiones fastón, negro	46,75	35,06	28,05	21,04
TTB740N02	40 conexiones fastón, rojo	54,38	40,78	32,63	24,47
TTB740N14	40 conexiones fastón, negro	53,32	39,99	31,99	23,99
Distribuidor de potencia a 4+4 puntos					
4+4 conexiones bus - Ø 8mm, Ø 10mm, 250A					
3 conexiones de 20A adicionales por lado					
738831N14	4x8mm + 4x8mm	60,95	45,71	36,57	30,48
738834N14	4x8mm(-) + 4x10mm(+)	61,37	46,03	36,82	30,69
738837N02	4x10mm + 4x10mm	63,60	47,70	38,16	31,80
738N3P05	Protector amarillo bus de 4+4	9,75	7,31	5,85	4,88

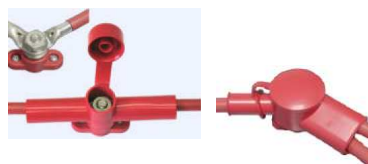
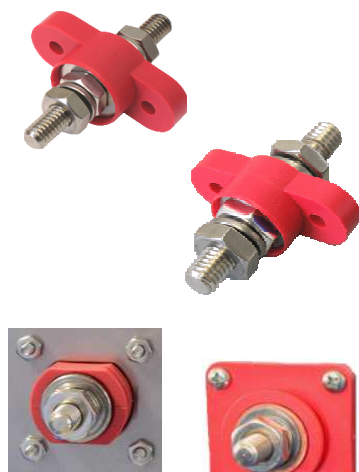

Ref.	Artículo	1-24	25+	100+	500+
------	----------	------	-----	------	------

Pasamuros 250A., panel grosor máx.10mm

77225N02	Borne 1/4" (6,35mm), rojo	23,53	17,65	14,12	10,59
77225N14	Borne 1/4" (6,35mm), negro	23,32	17,49	13,99	10,49
77231N02	Borne 5/16" (7,94mm), rojo	28,83	21,62	17,30	12,97
77231N14	Borne 5/16" (7,94mm), negro	28,41	21,31	17,04	12,78
77237N02	Borne 3/8" (9,53mm), rojo	19,40	14,55	11,64	8,73
77237N14	Borne 3/8" (9,53mm), negro	18,87	14,15	11,32	8,49
77208N02	Borne M8, rojo	27,67	20,75	16,60	12,45
77208N14	Borne M8, negro	27,24	20,43	16,35	12,26
77210N02	Borne M10, rojo	20,99	15,74	12,59	9,44
77210N14	Borne M10, negro	20,46	15,34	12,27	9,21

Pasamuros 450A., medida 5x4cm, panel grosor máx.10,7mm

CCFB106N02	borne M10, Rojo	28,73	21,54	17,24	12,93
CCFB106N14	borne M10, Negro	28,20	21,15	16,92	12,69
CCFB106N02W	borne M10, Rojo, Weatherproof	42,93	32,20	25,76	19,32
CCFB106N14W	borne M10, Negro, Weatherproof	42,40	31,80	25,44	19,08

Pasamuros 550A., medida 5x4cm, panel grosor máx.10,7mm

CCFB376N02	borne 3/8", Rojo	27,77	20,83	16,66	12,50
CCFB376N14	borne 3/8", Negro	27,14	20,35	16,28	12,21
CCFB376N02W	borne 3/8", Rojo, Weatherproof	44,10	33,07	26,46	19,84
CCFB376N14W	borne 3/8", Negro, Weatherproof	43,46	32,60	26,08	19,56

Pasamuros 450A., borne M10, panel grosor máx.10,3mm

CCB376M0N02	borne M10, Rojo+Negro	27,67	20,75	16,60	12,45
CCB376M0NR02	borne M10, Rojo	27,67	20,75	16,60	12,45
CCB376M0N14	borne M10, Negro	27,67	20,75	16,60	12,45
CCB376M0N02W	borne M10, Rojo+Negro, Weatherproof	33,50	25,12	20,10	15,07
CCB376M0NR02W	borne M10, Rojo, Weatherproof	33,50	25,12	20,10	15,07
CCB376M0N14W	borne M10, Negro, Weatherproof	33,50	25,12	20,10	15,07

Pasamuros 550A., borne 3/8", panel grosor máx.10,3mm

CCB376N0N02	borne 3/8", Rojo+Negro	29,04	21,78	17,43	13,07
CCB376N0NR02	borne 3/8", Rojo	29,04	21,78	17,43	13,07
CCB376N0N14	borne 3/8", Negro	29,04	21,78	17,43	13,07
CCB376N0N02W	borne 3/8", Rojo+Negro, Weatherproof	35,83	26,87	21,50	16,12
CCB376N0NR02W	borne 3/8", Rojo, Weatherproof	35,83	26,87	21,50	16,12
CCB376N0N14W	borne 3/8", Negro, Weatherproof	35,83	26,87	21,50	16,12

956D9V02	Protector doble entrada 1,8cm +tapa	6,04	4,53	3,63	2,72
795V02	Protector entrada cable simple y multiples cables + tapa	10,28	7,71	6,17	4,63

Protector terminal y Distribuidor de potencia Ø entrada cable max.18mm = +/-120mm²

480N9V05	Carcasa amarilla	9,12	6,84	5,47	4,10
479N9P02	Tapa superior roja (+)	1,38	1,03	0,83	0,62
479N9P14	Tapa superior negra (-)	1,38	1,03	0,83	0,62
477N0V05	Tapón lateral amarillo	2,01	1,51	1,21	0,91
478N3V09	Entrada cable azul	4,03	3,02	2,42	1,81

15.- CONEXIÓN DE ARRANQUE y PORTAFUSIBLES VTE

2025

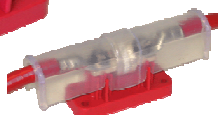
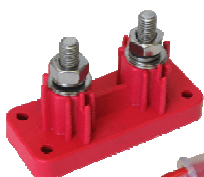
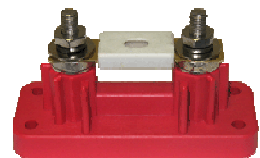
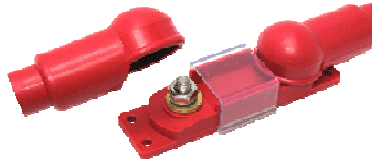

Ref.	Artículo	1-24	25+	100+	500+
------	----------	------	-----	------	------

Conexión auxiliar con tapa aislante, 50A. Max.48V.

7A373002	Panel 0-3,2mm Rojo	17,38	13,04	10,43	7,82
7A373014	Panel 0-3,2mm Negro	17,38	13,04	10,43	7,82
7A373102	Panel 3,2-6,3mm Rojo	17,81	13,36	10,68	8,01
7A373114	Panel 3,2-6,3mm Negro	17,81	13,36	10,68	8,01
7A373202	Panel 6,3-9,5mm Rojo	17,49	13,12	10,49	7,87
7A373214	Panel 6,3-9,5mm Negro	17,49	13,12	10,49	7,87

Conexión Arranque con tapa aislante, 350A. Max.48V.

CCJB376M0N02	M10, Panel 1-5 a 9,5mm Rojo	30,95	23,21	18,57	13,93
CCJB376M0N14	M10, Panel 1-5 a 9,5mm Negro	30,95	23,21	18,57	13,93
CCJB376FMKM	Kit empotrar 12,7x5,6cm+separador	68,69	51,52	41,21	30,91
CCJB376BMKM	Kit soporte L+ separador	80,14	60,10	48,08	36,06

Portafusibles tipo ANL/SIBA/PUDENZ (6,2cm borne a borne) para 50 a 500A, terminales de 5/16" (8mm), incluye: portafusibles + 2 protectores de borne serie 487 + tapa clara

ANB740N7N02	Cable Ø12,7mm, rojo +tapa+2 gomas	20,99	15,74	12,59	9,44
ANB740N7N14	Cable Ø12,7mm, negro +tapa+2 gomas	20,99	15,74	12,59	9,44
ANB740N8N02	Cable Ø15,2mm, rojo +tapa+2 gomas	20,88	15,66	12,53	9,40
ANB740N8N14	Cable Ø15,2mm, negro +tapa+2 gomas	20,88	15,66	12,53	9,40
ANB740N9N02	Cable Ø16,5mm, rojo +tapa+2 gomas	20,99	15,74	12,59	9,44
ANB740N9N14	Cable Ø16,5mm, negro +tapa+2 gomas	20,99	15,74	12,59	9,44
ANB740N0N02	Cable Ø19mm, rojo +tapa+2 gomas	20,25	15,18	12,15	9,11
ANB740N0N14	Cable Ø19mm, negro +tapa+2 gomas	20,25	15,18	12,15	9,11
487N6V02	Protector Cable Ø12,7mm, rojo	2,23	1,92	1,28	1,06
487N7V02	Protector Cable Ø15,2mm, rojo	2,23	1,92	1,28	1,06
487N8V02	Protector Cable Ø16,5mm, rojo	2,23	1,92	1,28	1,06
487N9V02	Protector Cable Ø19mm, rojo	2,23	1,92	1,28	1,06

Portafusibles tipo ANL/SIBA/PUDENZ (6,2cm borne a borne) Hi-Amp hasta 750A, incluye: portafusibles + tapa larga transparente

ANB753N7N02	Terminal 5/16", rojo +tapa clara	61,37	46,03	36,82	27,62
ANB753N7N14	Terminal 5/16", negro +tapa clara	61,37	46,03	36,82	27,62
ANB753N8N02	Terminal 3/8", rojo +tapa clara	48,97	36,73	29,38	22,04
ANB753N8N14	Terminal 3/8", negro +tapa clara	48,97	36,73	29,38	22,04
ANB753N9N02	Terminal M10, rojo +tapa clara	78,44	58,83	47,06	35,30
ANB753N9N14	Terminal M10, negro +tapa clara	78,44	58,83	47,06	35,30

Portafusibles tipo MEGA (5cm borne a borne), incluye: portafusibles + 2 protectores de borne serie 405

MFB736N9N02	MEGA Fuses, rojo + 2x 405N9	16,75	12,56	10,05	7,54
MFB736N9N14	MEGA Fuses, negro + 2x 405N9	16,11	12,08	9,67	7,25
405N1V02	Protector Ø25,4mm Cable Ø3,3/9,3mm	1,38	1,30	0,86	0,71
405N2V02	Protector Ø25,4mm Cable Ø7,6/12,7mm	1,38	1,30	0,86	0,71
405N9V02	Protector Ø25,4mm Cable Ø12,7mm	1,38	1,30	0,86	0,71

Portafusibles para Clase T (4,7cm borne a borne)

TFB735N0N02	T-Class Fuses, rojo	25,23	18,92	15,14	11,35
TFB735N0N14	T-Class Fuses, negro	24,06	18,05	14,44	10,83
TFB735N8N02 +cover	T-Class Fuses, rojo, con tapa	29,79	22,34	17,87	13,40
TFB735N8N14 +cover	T-Class Fuses, negro, con tapa	29,79	22,34	17,87	13,40

Gama SW60

Volatjes: 6 - 130V.

Capacidad de corte: 1kw Max.

Continuo: 80A

Interm.50%: 115A

5ms: 500A



Gama SU60

Volatjes: 6 - 130V.

Capacidad de corte: 1kw Max.

Continuo: 100A

Interm.50%: 150A

5ms: 500A



Ref.	Articulo	P.V.P.
SERIE SW60 - Contactor simple 1 polo 80A		
SW60-1	CONTACTOR SIMPLE 12V	37,40
SW60-2	CONTACTOR SIMPLE 12V CO	37,40
SW60-38P	CONTACTOR SIMPLE PROTEGIGO 12V CO	40,70
SW60-3	CONTACTOR SIMPLE 24V	37,40
SW60-4	CONTACTOR SIMPLE 24V CO	37,40
SW60-40P	CONTACTOR SIMPLE PROTEGIGO 24V CO	40,70
SW60-6	CONTACTOR SIMPLE 36V CO	37,40
SW60B-7	CONTACTOR SIMPLE 48V	37,40
SW60AB-xxx	CONTACTOR SIMPLE +Microauxiliar A	56,30
SW60CB-xxx	CONTACTOR SIMPLE +Microauxiliar C	41,55

SERIE SW61 - Contactor conmutador 1 polo N.A. 80A		
SW61-2	CONTACTOR CONMUTADOR 12V CO	45,00
SW61-4	CONTACTOR CONMUTADOR 24V CO	45,00
SW61C-191	Contactor Conmutador 24V CO +Micro C	54,50
SW61AB-210	Contactor Conmutador 54V CO +Micro A	64,20

SERIE SW63 - Contactor simple 1 polo N.C. 80A		
SW63-2	CONTACTOR SIMPLE N.C. 12V CO	42,10
SW63-4	CONTACTOR SIMPLE N.C. 24V CO	42,10

SERIE SW66 - DC66 - Contactor inversor 1 polo N.A. 80A		
SW66-2	CONTACTOR INVERSOR 12V CO	114,00
SW66-4	CONTACTOR INVERSOR 24V CO	114,00
DC66-1P	INVERSOR Monobloc 12V IP66	99,30
DC66-3P	INVERSOR Monobloc 24V IP66	99,30

SERIE DC64 - Doble Contactor simple 1 polo N.A. 80A		
DC64-11P	CONT.DOUBLE 12V.HO +IP66 +soporte Omega	79,40

SERIE SW68 - Contactor doble polo N.A. 80A		
SW68-51	CONTACTOR Doble Polo 12V.CO +D +3060-94	63,00
SW68-32	CONTACTOR Doble Polo 24V.CO + 3060-94	56,00

Accesorios		
3060-94	SOPORTE OMEGA SW60 / SU60	1,75
3060-340	SOPORTE CARRIL DIN SW60 / SU60	1,95

SERIE SU60 - Contactor simple 1 polo 100A		
SU60B-2009	CONTACTOR SIMPLE 24V.CO	43,35
SU60B-2033	CONTACTOR SIMPLE 60V CO	43,35
SU60B-2049	CONTACTOR SIMPLE 80V CO	43,35
SU60B-2410P	CONT.SIMPLE 12V CO +IP66 +soporte omega	47,20
SU60B-2013P	CONT.SIMPLE 24V CO +IP66 +soporte omega	47,20
SU60B-2261P	CONT.SIMPLE 60V CO +IP66 +soporte omega	47,20
SU60AB-xxx	CONT.SIMPLE 60V CO +Microauxiliar A	61,75

Accesorios		
3060-94	SOPORTE OMEGA SW60 / SU60	1,75
3060-340	SOPORTE CARRIL DIN SW60 / SU60	1,95

1.- CONTACTORES DE POTENCIA ALBRIGHT

2026

Gama SW80

Volatjes: 6 - 240V.

Capacidad de corte: 3kw Max.

Continuo: 100A

Interm.50%: 150A

5ms: 800A

Telecom: 125A



Micro tipo A

Single Pole Single Throw (On/Off) Contactor

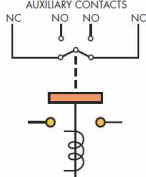

Micro tipo C

Single break changeover switch

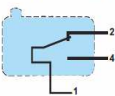

SERIE SW80 - Contactor simple 1 polo N.A. 100A

SW80-3	CONTACTOR SIMPLE 12V	63,80
SW80B-5	CONTACTOR SIMPLE 12V.CO	63,80
SW80-56	CONTACTOR SIMPLE 12V c/brida integrada	63,80
SW80-1	CONTACTOR SIMPLE 24V	63,80
SW80-6	CONTACTOR SIMPLE 24V.CO	63,80
SW80B-9	CONTACTOR SIMPLE 48V	63,80
SW80B-40	CONTACTOR SIMPLE 36/48V.CO	63,80
SW80B-62	CONTACTOR SIMPLE 72/80V.CO	63,80
SW80-4	CONTACTOR SIMPLE 24V c/brida integrada	63,80
SW80-1005L	CONTACTOR SIMPLE 24V esp. BT (equ.-740L)	70,30
SW80-739L	CONTACTOR SIMPLE 24V esp. MIC	70,30
SW80AB-19	CONTACTOR SIMPLE 24V.CO c/microaux.A	96,90
SW80AB-268	CONTACTOR SIMPLE 55V.CO c/microaux.A	96,90
SW80CB-2365	CONTACTOR SIMPLE 24V.CO c/microaux.C	77,90
SW80-374P	CONT.SIMPLE PROTEGIDO 12V c/soporte	73,00
SW80-375P	CONT.SIMPLE PROTEGIDO 24V c/soporte	73,00

SERIE SW82 - Contactor bipolar 2 polos N.A. 100A

SW82-1	CONT.DOUBLE POLO 12V	95,00
SW82-3	CONT.DOUBLE POLO 24V	95,00
SW82-4	CONT.DOUBLE POLO 24V CO	98,20
SW82-76P	CONT.DOUBLE POLO 24V PROTEGIDO	110,00
SW82-52	CONT.DOUBLE POLO 48V.CO c/brida integr.	98,15

SERIE SW822 - Contactor inversor bipolar 2 polos N.A. 100A

SW822-1	PAR DE CONTACTORES DOBLE POLO 12V	212,00
SW822-3	PAR DE CONT.DOUBLE POLO 24V	212,00
SW822-73L	PAR DE CONT.DOUBLE POLO 24V esp. MIC	228,00
SW822-82L	PAR DE CONT.DOUBLE 24V (equ.-74L BT)	228,00
SW822-47P	PAR DE CONT.DOUBLE 12V PROTEGIDO	228,00
SW822-54P	PAR DE CONT.DOUBLE 24V.CO PROTEGIDO	228,00

SERIE SW84 - Contactor conmutador 1 polo N.A. 100A

SW84-3	CONTACTOR CONMUTADOR 12V	98,20
SW84-1	CONTACTOR CONMUTADOR 24V	98,20
SW84-4	CONTACTOR CONMUTADOR 24V.CO	98,20
SW84B-8	CONTACTOR CONMUTADOR 48V.CO	98,20
SW84A-60	CONTACTOR CONMUTADOR 48V.CO	127,00

SERIE SW85 - Contactor simple 1 polo N,C. 100A

SW85-20	C.SIMPLE Normalmente CERRADO 12V.CO	80,20
SW85-2	C.SIMPLE Normalmente CERRADO 24V.CO	80,20
SW85-13	C.SIMPLE Normalmente CERRADO 36V.CO	80,20

SERIE SW88 - Contactor inversor 1 polo N.A. 100A

SW88-3	CONTACTOR DOBLE 12V	196,00
SW88-1	CONTACTOR DOBLE 24V	184,00
SW88B-76	CONTACTOR DOBLE 36/48V	196,00
SW88B-73	CONTACTOR DOBLE 72/80V	196,00

1.- CONTACTORES DE POTENCIA ALBRIGHT

2026

Gama DC88

Volatjes: 6 - 240V.

Capacidad de corte: 3kw Max.

Continuo: 100A

Interm.50%: 150A

5ms: 800A



SW80



SW82



SW84



DC88

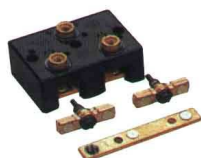

2070-863

Kit Completo

DC88 =

133,00 €

SERIE DC88 - Contactor inversor Monobloc 1 polo N.A. 100A

DC88-2	INVERSOR 12V.CO	185,00
DC88-286L	INVERSOR 12V pastilla ancha	185,00
DC88-313P	INVERSOR 12V CO PROTEGIDO	189,00
DC88-1	CONTACTOR INVERSOR 24V c/sop.integrado	167,00
DC88-317T	INVERSOR 24V c/obturadores + s/soporte	167,00
DC88B-331	INVERSOR 24V esp.NISSAN	185,00
DC88-282P	INVERSOR 24V PROTEGIDO	189,00
DC88-6	INVERSOR 36V.CO	185,00
DC88B-374	INVERSOR 48V.c/obturad.s/sop.	185,00

SERIE DC92 - Doble Contactor simple 1 polo N.A. 100A

DC92-207	CONTACTOR DOBLE 12V sin soporte	127,00
DC92-208	CONTACTOR DOBLE 24V sin soporte	127,00
DC92-223L	CONTACTOR DOBLE 24V.CO esp.MIC	142,00
DC92-261P	DOBLE 12V +diodos +s/soporte IP66	145,00
DC92-262P	DOBLE 24V +diodos +s/soporte IP66	145,00

Accesorios serie SW80 - DC88

2070-40	SOPORTE FIJACION EN L PARA SW80	1,95
2126-48A	SOPORTE FIJACION EN OMEGA SW80	1,95
2071-428	SOPORTE FIJACION CARRIL DIN SW80	1,95
2070-41	SOPORTE FIJACION SW822 - DC88 /92	4,85
2070-124	MICRO AUXILIAR PARA SW80 /84 /88	35,55
2070-413	MICRO AUXILIAR PARA DC88	35,55
2028-577	JUEGO CONTACTOS SW62A	48,00
2070-57	JUEGO CONTACTOS SW80	32,00
2070-194	JUEGO CONTACTOS SW80L	43,00
2070-90	JUEGO CONTACTOS SW82	56,00
2070-90A	JUEGO CONTACTOS SW82L	76,00
2070-193	JUEGO CONTACTOS SW84	49,00
2070-151	JUEGO CONTACTOS SW88	101,50
2070-222	JUEGO CONTACTOS SW88L	125,00
2065-183	JUEGO CONTACTOS SW89	78,00
2070-4	TAPA SW80	11,60
2070-61	TAPA SW82	11,60
2070-4A	TAPA SW84 / SW88	11,60

2070-360A	TAPA DC88	55,60
2070-14	CONTACTO MOVIL DC88	29,30
2070-326	CONTACTO FIJO DC88	18,80

DISTRIBUIDOR OFICIAL



1.- CONTACTORES DE POTENCIA ALBRIGHT

2026

Gama SW180

Volatjes: 6 - 240V.

Capacidad de corte: 6kw Max.

Continuo: 150A

Interm.50%: 225A

5ms: 1000A

Telecom: 200A



Gama DC182

Volatjes: 6 - 240V.

Capacidad de corte: 6kw Max.

Continuo: 150A

Interm.50%: 225A

5ms: 1000A



DC182 sin soporte
8 agujeros por lado

DC182 con soporte
integrado

SERIE SW180 - Contactor simple 1 polo N.A. 150A

SW180-1	CONTACTOR SIMPLE 12V	96,00
SW180-2	CONTACTOR SIMPLE 12V.CO	96,00
SW180-3	CONTACTOR SIMPLE 24V	96,00
SW180-4	CONTACTOR SIMPLE 24V CO	96,00
SW180B-93	CONTACTOR SIMPLE 36/48V	96,00
SW180B-195	CONTACTOR SIMPLE 36/48V CO	96,00
SW180B-440	SIMPLE 48V.PO +V.I.+c/obt.+AMP esp. JLG	119,00
SW180AB-441	SIMPLE 48V.CO +Micro +V.I.+c/obt.+AMP esp. JLG	143,00
SW180B-15	CONTACTOR SIMPLE 72/80V	96,00
SW180B-16	CONTACTOR SIMPLE 72/80V.CO	96,00

SERIE SW181 - Contactor conmutador 1 polo N.A. 150A

SW181-3	CONMUTADOR 24V	139,00
SW181-4	CONMUTADOR 24V CO	139,00
SW181-267T	CONMUTADOR 24V.PO c/obturad.	139,00
SW181B-93	CONMUTADOR 36/48V	139,00
SW181B-198	CONMUTADOR 36/48V CO	139,00
SW181B-216T	CONMUTADOR 48V.PO c/obturad.	139,00
SW181B-196	CONMUTADOR 48V.+V.I.+c/obt.+AMP esp. JLG	159,00
SW181B-248T	CONMUTADOR 80V.PO	139,00
SW181-241T	CONMUTADOR 24V Texturado NISSAN	156,00

SERIE SW182 - Contactor inversor 1 polo N.A. 150A

SW182-1	CONTACTOR DOBLE 12V	292,00
SW182-3	CONTACTOR DOBLE 24V	292,00
SW182B-93	CONTACTOR DOBLE 36/48V	292,00
SW182B-299	INVERSOR 48V +V.I.+c/obt.+2 sop.L esp. JLG	358,00
SW182B-15	CONTACTOR DOBLE 72/80V	292,00

SERIE SW190 - Contactor bipolar 2 polos N.A. 150A

SW190-3	CONTACTOR SIMPLE 4 BORNES 24V	151,00
SW190B-93	CONTACTOR SIMPLE 4 BORNES 36/48V	151,00

SERIE SW192 - Contactor inversor bipolar 2 polos N.A. 150A

SW192-3	CONTACTOR DOBLE 24V	311,00
SW192B-93	CONTACTOR DOBLE 36/48V	311,00

SERIE DC182 - Contactor inversor Monobloc 1 polo N.A. 150A

DC182-1	CONTACTOR INVERSOR 12V	252,00
DC182-3	CONTACTOR INVERSOR 24V c/sop.integrado	252,00
DC182B-93	CONTACTOR INVERSOR 36/48V c/sop.integr.	252,00
DC182B-419	CONTACTOR INVERSOR 48V esp. CLARK	252,00
DC182B-15	CONT.INVERSOR 72-80V c/sop.integrado	252,00
DC182B-537T	CONT.INVERSOR 48V c/obt. esp. CLARK -538T	252,00
DC182-583T	CONT.INVERSOR 24V (equ.-541T) c/obturad.	252,00
DC182B-648T	CONT.INVERSOR 48V c/obturad.	252,00
DC182B-588	INVERSOR 48V +V.I.+c/obt.+2 sop.L esp. JLG	298,00
DC182B-581T	CONTACTOR INVERSOR 80V	252,00

DC184AB-429L	CONTACTOR DOBLE 48V+ V.I. especial JLG	313,00
--------------	---	--------



SERIE SW180 especiales - Contactor simple 1 polo N.A. 150A

SW180-774	SIMPLE 12V + Pulsador cierre manual	151,00
SW180-775	SIMPLE 24V + Pulsador cierra manual	151,00

SW180



Accesorios serie SW180 - DC182

2159-47	SOPORTE OMEGA PARA SW180	2,55
2155-165	SOPORTE L PARA SW180	2,55
2159-39	SOPORTE FIJACION SW182 /DC182	5,70

SW181

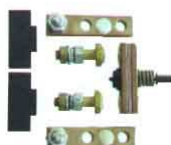

2159-117	MICRO AUXILIAR PARA SW180/181/182	35,55
----------	-----------------------------------	-------

2180-42	JUEGO CONTACTOS SW180	48,00
2180-42A	JUEGO CONTACTOS SW180L	65,00
2180-43	JUEGO CONTACTOS SW181	81,00
2180-43A	JUEGO CONTACTOS SW181L	112,00
2180-516	JUEGO CONTACTOS SW182 +muelles	187,00
2180-44A	JUEGO CONTACTOS SW182L	243,00
2180-362	JUEGO CONTACTOS SW190	75,35
2180-362A	JUEGO CONTACTOS SW190L	112,00

DC182



2180-839A

Kit Completo

DC182 =

227,00 €

2180-151	TAPA SW192	11,60
2180-25A	TAPA SW180B	17,45
2180-25B	TAPA SW181B	17,45

2180-41	OBTURADOR PROTECCION SW180	1,40
2180-403	OBTURADOR PROTECCION DC182	1,40

2180-270C	CABEZAL DC182	111,50
2180-29	CONTACTO MOVIL DC182	44,30
2180-325	CONTACTO FIJO DC182/DC182L	26,90

2180-518	JUEGO CONTACTOS DC182B (esp.LINDE) con salida a ambos lados	192,00
----------	---	--------

Gama SU80

Volatjes: 6 - 240V.

Capacidad de corte: 1kw Max.

Continuo: 150A

Interm.50%: 210A

5ms: 800A

Telecom: 200A

SERIE SU80 - Contactor simple 1 polo N.A. 150A

SU80-xxxM	SIMPLE Biestable	89,60
SU80A-xxxM	SIMPLE Biestable + Microauxiliar	122,00
SU80-xxx	SIMPLE	75,45
SU80B-5000	SIMPLE 12V.CO + Soplado Magnético	79,20
SU80AB-5158	SIMPLE 24V.CO +Sopl.Magnético +Microauxiliar	106,00
SU80CB-5267	SIMPLE 24V.CO +Sopl.Magnético +Microauxiliar	85,30
SU80B-5505F	SIMPLE 54V.CO + Protegido	89,40

DISTRIBUIDOR OFICIAL



Gama SW200

Volatjes: 6 - 240V.

Capacidad de corte: 15kw Max.

Continuo: 250A

Interm.50%: 360A

5ms: 1500A

Telecom: 400A



SERIE SW200 - Contactor simple 1 polo N.A. 250A

SW200-22	CONTACTOR SIMPLE 12V	217,00
SW200-3	CONTACTOR SIMPLE 12V CO	224,00
SW200-714	CONTACTOR SIMPLE 14V CO + tapa cerrada	224,00
SW200-2	CONTACTOR SIMPLE 24V	217,00
SW200-29	CONTACTOR SIMPLE 24V CO	224,00
SW200-122	CONTACTOR SIMPLE 28V CO + tapa cerrada	224,00
SW200-102	CONTACTOR SIMPLE 36/48V	217,00
SW200-279	CONTACTOR SIMPLE 36/48V CO	224,00
SW200-104	CONTACTOR SIMPLE 60V	217,00
SW200-314	CONTACTOR SIMPLE 72/80V	217,00
SW200-21	CONTACTOR SIMPLE 72/80V CO	224,00
SW200-27	CONTACTOR SIMPLE 96V CO	224,00
SW200-19	CONTACTOR SIMPLE 110V CO	224,00
SW200A-24	CONTACTOR SIMPLE C/MICROAUX.24V	261,00
SW200A-3648	CONTACTOR SIMPLE C/MICROAUX.36/48V	261,00

SERIE SW201 - Contactor conmutador 1 polo N.A. 250A

SW201-2	CONTACTOR CONMUTADOR 24V	294,00
SW201-253T	CONMUTADOR 24V.PO +pastilla texturada	294,00
SW201-31	CONTACTOR CONMUTADOR 48V	294,00
SW201-195	CONTACTOR CONMUTADOR 48V.PO	294,00
SW201-199	CONTACTOR CONMUTADOR 72/80V	294,00
SW201-4	CONTACTOR CONMUTADOR 96V CO	294,00
SW201C-414	CONMUTADOR 28V.CO + Micro V3 conmutador	307,00
SW201A-12	CONMUTADOR 24V + Microauxiliar	335,00
SW201A-32	CONMUTADOR 48V + Microauxiliar	335,00

SERIE SW210 - Contactor conmutador 1 polo N,C. 250A

SW210-274	SIMPLE Normalmente Cerrado 24V.CO	296,00
SW210A-48	SIMPLE Normalmente Cerrado 24V.CO + Micro	325,00

SERIE SW215 - Contactor conmutador 1 polo N.A. 250A

SW215-17	INVERSOR 48V especial LINDE	443,00
SW215-16	INVERSOR 80V especial LINDE	443,00
SW215A-9	INVERSOR 48V + Microauxiliar esp.LINDE	479,00
SW215A-8	INVERSOR 80V + Microauxiliar esp.LINDE	479,00

SERIE SW202 - Contactor inversor 1 polo N.A. 250A

SW202-9	CONTACTOR DOBLE 12V	581,00
SW202-37	CONTACTOR DOBLE 24V + Tapa cerrada	581,00
SW202-66	CONTACTOR DOBLE 36/48V	581,00
SW202-95	CONTACTOR DOBLE 72/80V	581,00
SW202A-24	CONTACTOR DOBLE C/AUX. 24V	656,00
SW202A-3648	CONTACTOR DOBLE C/AUX. 36/48V	656,00
SW204A-147	2x CONT.SIMPLE SW200 24V.CO + Micro	578,00



SERIE SW200 especiales - Contactor simple 1 polo N.A. 250A

SW200-858M BIESTABLE 12V + Pulsador cierre manual	327,00
SW200A-1040M BIESTABLE 24V +Micro + Pulsador cierre manual	367,00

SERIE SW200 - Contactor simple 1 polo N.A. salida lateral 250A

SW200-767M BIESTABLE 12V.	238,00
SW200AN-766M BIESTABLE 24V + Micro auxiliar	270,00

SERIE SW206 - Contactor simple 1 polo N.C. salida lateral 250A

SW206-11 CONTACTOR 24V.CO	320,00
SW206-21M BIESTABLE 12V + Pulsador apertura manual	404,00
SW206-20M BIESTABLE 24V + Pulsador apertura manual	404,00

Accesorios serie SW200

2155-165	SOPORTE L PARA SW180/SW200	2,55
2028-551A	SOPORTE OMEGA PARA SW180/SW200	2,55
2155-228	MICRO AUXILIAR PARA SW200/201/202	35,60
2155-352	MICRO AUXILIAR PARA SW215	35,60
2155-99	JUEGO CONTACTOS SW200	87,00
2155-250	JUEGO CONTACTOS SW201	129,00
2155-136	JUEGO CONTACTOS SW202	274,00
2155-506	JUEGO CONTACTOS SW215A (LINDE)	173,00
2155-65	TAPA SW200 + IMANES (soplado magnético)	30,00
2155-65A	TAPA SW201 + IMANES	30,00
2155-65G	TAPA SW200 + IMANES + tapa cerrada	30,00
2155-3	TAPA SW200N SIN IMANES	13,70

SW200



SW201



SW202



Gama SU280

Volatjes: 6 - 240V.

Capacidad de corte: 6kw Max.

Continuo: 250A

Interm.50%: 495A

5ms: 1500A

Telecom: 350A

Gama SU190

Volatjes: 6 - 240V.

Cap.de corte: 6kw Max.

Continuo: 250A

Interm.50%: 360A

5ms: 1500A

Telecom: 350A



SERIE SU280 - Contactor simple 1 polo N.A. 250A

SU280-1179M SIMPLE 12V. Biestable	192,00
SU280-1004 SIMPLE 24V.CO	146,00
SU280B-1010 SIMPLE 48V.CO	146,00
SU280-1067P SIMPLE 24V. + Protegido	166,00
SU280-1068P SIMPLE 24V.CO + Protegido	170,00

SERIE SU190 - Contactor simple 2 polos N.A. 250A

SU190-xxxM BIPOLAR Biestable	213,00
SU190A-xxxM BIPOLAR Biestable + Microauxiliar	219,00
SU190-xxx BIPOLAR	191,00
SU190B-xxx BIPOLAR + Soplado Magnético	196,00
SU190A-xxx BIPOLAR + Microauxiliar	221,00
SU190AB-xxx BIPOLAR + Soplado Magnético + Microauxiliar	227,00

DISTRIBUIDOR OFICIAL



1.- CONTACTORES DE POTENCIA ALBRIGHT

2026

Gama MC50

Volatjes: 12 - 120V.

Capacidad de corte: 6kw Max.

Continuo: 50A (65A)

Interm.50%: 70A (88A)

5ms: 400A



SERIE MC50 - Contactor simple 1 polo N.A. 50A (65A) 60V

MC50-5	SIMPLE 12V.	23,90
MC50-3	SIMPLE 12V.CO	23,90
MC50-8	SIMPLE 24V.	23,90
MC50-6	SIMPLE 24V.CO	23,90
MC50-16	SIMPLE 48V.	23,90
MC50-14	SIMPLE 48V.CO	23,90

Gama HV500

Volatjes en potencia: 12 - 1000V.

Capacidad de corte: 15kw Max.

Continuo: 500A (190mm²)



SERIE HV500 - Contactor simple 1 polo N.A. 500A 1000V

HV500F	HIGH VOLTAGE	166,00
HV500AF	HIGH VOLTAGE + AUXILIAR	187,00
HV500FS	HIGH VOLTAGE + SILVER TIPS	200,00
HV500AFS	HIGH VOLTAGE + AUXILIAR + SILVER TIPS	220,00
HV505F	High voltage Normally closed	191,00
HV505AF	High voltage Normally closed + AUXILIAR	212,00
B2-B7	Opción control PWM interno 12, 24, 48, 60, 72, 84V	40,70
W3	Opción mircoauxiliar MIRROR	44,95

1.- CONTACTORES DE POTENCIA ALBRIGHT

2026

Paros de emergencia

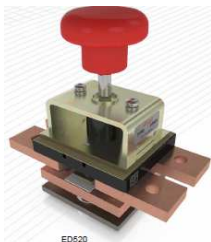

Paro de emergencia + Contactor de Línea



Hauotte 2440306180

SERIE ED80, ED125 y ED150 - Cortadores de corriente hasta 150A

ED80-1	80A hasta 48V	46,20
ED125-1	125A hasta 48V	71,30
ED125AB	125A hasta 96V + Microaux.+ sopl.mag.	121,00
ED125L-1	125A hasta 48V + llave	119,00
ED150-1	150A hasta 48V	74,90

SERIE ED250 / ED252 - Cortador de corrientes hasta 250A

ED250B-61	PARO SIMPLE + soplado magnético	101,00
ED250AB-2	PARO SIMPLE + microauxiliar + sopl.mag.	138,00
ED250LB	PARO SIMPLE +llave +sopl.mag.	156,00
ED250LAB-2	PARO SIMPLE +llave +microaux.+sopl.mag.	170,00
ED252-13	PARO 2 POLOS c/sopl.mag.	128,00
ED252AB	PARO 2 POLOS +microaux.+sopl.mag.	157,00

SERIE ED402 - Cortador de corrientes hasta 400A

ED402-1	PARO SIMPLE	379,00
---------	-------------	--------

SERIE ED520 - Cortador de corrientes dos polos hasta 500A

ED520-1	PARO 2 POLOS	767,00
ED520A	PARO 2 POLOS + Microauxiliar 1xNA+1xNC	790,00
ED520C	PARO 2 POLOS + Microauxiliar conmutado	773,00

SERIES antiguas años 80 y 90

SW155-1	PARO EMERGENCIA 2 POLOS	195,00
SW159-1	PARO EMERGENCIA 1 POLO	160,00

SERIE ED1200 / ED1800 - Cortador de corrientes hasta 1800A

ED1200-1	PARO SIMPLE 1 POLO 1200A	690,00
ED1800-1	PARO SIMPLE 1 POLO 1800A	898,00

SERIE SD150A - Paro emergencia + contactor línea 150A

SD150A-2	24V.CO + Microauxiliar HAULOTTE	135,00
SD150A-27	24V.CO +Microauxiliar MIC-JUNGHEINRICH	153,00
2555-37	SETA cuadrada naranja-amarilla JUNGHEINRICH	21,40
SD150A-30	24V + Microauxiliar	153,00

SERIE SD250A - Paro emergencia + contactor línea 250A

SD250A-3	24V.+ Microauxiliar	182,00
SD250AB-2	48V.+ Microauxiliar	182,00
SD250AB-8	80V.+ Microauxiliar	182,00

SERIE SD200A - Paro emergencia + contactor línea 200A

SD200	voltage a determinar	128,00
SD200A	voltage a determinar + Microauxiliar	153,00

SERIE SD300A - Paro emergencia + contactor línea 300A

SD300	voltage a determinar	182,00
SD300A	voltage a determinar + Microauxiliar	210,00

Accesorios y recambios PAROS DE EMERGENCIA

2555-26	JUEGO CONTACTOS ED125	33,00
2200-63	JUEGO CONTACTOS ED250	42,00
2200-64	JUEGO CONTACTOS ED252	82,00
2200-228	JUEGO CONTACTOS SD250	44,00
2200-6	POMO ROJO ED125 / ED250	6,80
2200-6A	POMO NEGRO ED125 / ED250	8,90
2555-37	POMO CUADRADO amarillo-naranja MIC-JUNGHEINRICH	21,40

Aplicación Telecomunicaciones,
centros de distribución, SAI's/UPS

Conexión a busbar / a barra de cobre
de medidas mínimas establecidas según catálogo



opción biestable: +11-€

Especial para
encajar en 1U rack

biestable: +11-€



biestable: +11-€



biestable: +28-€



biestable: +19-€

biestable: +28-€

biestable: +28-€

biestable: +42-€

Contactor simple polo, N.A., conexión barra de cobre

SW150	CONTACTOR SIMPLE 150A	80,00
SW150A	CONTACTOR SIMPLE 150A + microauxiliar	119,00
SW150-M	CONTACTOR SIMPLE 150A + biestable	91,00
SW150A-M	CONTACTOR SIMPLE 150A +micro + biestable	130,00
SW225	CONTACTOR SIMPLE 225A	92,00
SW225A	CONTACTOR SIMPLE 225A + microauxiliar	133,00
SW225-M	CONTACTOR SIMPLE 225A + biestable	103,00
SW225A-M	CONTACTOR SIMPLE 225A +micro + biestable	144,00
SW250	CONTACTOR SIMPLE 250A	92,00
SW250A	CONTACTOR SIMPLE 250A + microauxiliar	133,00
SW250-M	CONTACTOR SIMPLE 250A + biestable	103,00
SW250A-M	CONTACTOR SIMPLE 250A +micro + biestable	144,00
SW300	CONTACTOR SIMPLE 300A	151,00
SW300A	CONTACTOR SIMPLE 300A + microauxiliar	192,00
SW300-M	CONTACTOR SIMPLE 300A + biestable	162,00
SW300A-M	CONTACTOR SIMPLE 300A +micro + biestable	203,00
SW400	CONTACTOR SIMPLE 400A	181,00
SW400A	CONTACTOR SIMPLE 400A + microauxiliar	221,00
SW400-M	CONTACTOR SIMPLE 400A + biestable	209,00
SW400A-M	CONTACTOR SIMPLE 400A +micro + biestable	249,00
SW260	CONTACTOR SIMPLE 300A	181,00
SW260A	CONTACTOR SIMPLE 300A + microauxiliar	221,00
SW260-M	CONTACTOR SIMPLE 300A + biestable	209,00
SW260A-M	CONTACTOR SIMPLE 300A +micro + biestable	249,00
SW500	CONTACTOR SIMPLE 500A	204,00
SW500A	CONTACTOR SIMPLE 500A + microauxiliar	244,00
SW500-M	CONTACTOR SIMPLE 500A + biestable	232,00
SW500A-M	CONTACTOR SIMPLE 500A +micro + biestable	271,00
SW560	CONTACTOR SIMPLE 600A	238,00
SW560A	CONTACTOR SIMPLE 600A + microauxiliar	277,00
SW560-M	CONTACTOR SIMPLE 600A + biestable	266,00
SW560A-M	CONTACTOR SIMPLE 600A +micro + biestable	305,00
SW600	CONTACTOR SIMPLE 600A	443,00
SW600A	CONTACTOR SIMPLE 600A + microauxiliar	471,00
SW600-M	CONTACTOR SIMPLE 600A + biestable	485,00
SW600A-M	CONTACTOR SIMPLE 600A +micro + biestable	513,00

1.- CONTACTORES DE POTENCIA ALBRIGHT

2026



	SW800	CONTACTOR SIMPLE 800A	568,00
	SW800A	CONTACTOR SIMPLE 800A	597,00
biestable: +42-€	SW800-M	CONTACTOR SIMPLE 800A + biestable	610,00
	SW800A-M	CONTACTOR SIMPLE 800A +micro + biestable	638,00

	SW1000	CONTACTOR SIMPLE 1200A	773,00
	SW1000A	CONTACTOR SIMPLE 1200A + microauxiliar	802,00
biestable: +52-€	SW1000-M	CONTACTOR SIMPLE 1200A + biestable	825,00
	SW1000A-M	CONTACTOR SIMPLE 1200A +micro + biestable	854,00

	SW1500	CONTACTOR SIMPLE 1800A	984,00
	SW1500A	CONTACTOR SIMPLE 1800A + microauxiliar	1.012,00
biestable: +52-€	SW1500-M	CONTACTOR SIMPLE 1800A + biestable	1.036,00
	SW1500A-M	CONTACTOR SIMPLE 1800A +micro + biestable	1.062,00

	SW2000	CONTACTOR SIMPLE 2000A	1.105,00
	SW2000A	CONTACTOR SIMPLE 2000A + microauxiliar	1.132,00
biestable: +52-€	SW2000-M	CONTACTOR SIMPLE 2000A + biestable	1.157,00
	SW2000A-M	CONTACTOR SIMPLE 2000A +micro + biestable	1.184,00

OPCIONES:



	SW2400	CONTACTOR SIMPLE 3000A	1.548,00
	SW2400A	CONTACTOR SIMPLE 3000A + microauxiliar	1.604,00
biestable: +52-€	SW2400-M	CONTACTOR SIMPLE 3000A + biestable	1.600,00
	SW2400A-M	CONTACTOR SIMPLE 3000A +micro + biestable	1.655,00

Contactor doble polo, N.A., conexión barra de cobre



	SW520	CONTACTOR SIMPLE 600A	773,00
	SW520A	CONTACTOR SIMPLE 600A + microauxiliar	802,00
biestable: +28-€	SW520-M	CONTACTOR SIMPLE 600A + biestable	801,00
	SW520A-M	CONTACTOR SIMPLE 600A +micro + biestable	829,00



Contactor simple polo, conmutador, conexión barra de cobre



	SW802	CONTACTOR CONMUTADOR 800A	813,00
	SW802A	CONTACTOR CONMUTADOR 800A + microauxil	842,00
biestable: +42-€	SW802-M	CONTACTOR CONMUTADOR 800A + biestable	855,00
	SW802A-M	CONT.CONMUTADOR 800A +micro + biestable	890,00



	SW1002	CONTACTOR CONMUTADOR 1200A	1.428,00
	SW1002A	CONTACTOR CONMUTADOR 1200A + micro	1.454,00
biestable: +52-€	SW1002-M	CONTACTOR CONMUTADOR 1200A + biestable	1.480,00
	SW1002A-M	CONT.CONMUTADOR 1200A +micro + biestable	1.505,00



	SW1502	CONTACTOR CONMUTADOR 1800A	2.875,00
	SW1502A	CONTACTOR CONMUTADOR 1800A + micro	2.904,00
biestable: +35-€	SW1502-M	CONTACTOR CONMUTADOR 1800A + biestable	2.927,00
	SW1502A-M	CONT.CONMUTADOR 1800A +micro + biestable	2.956,00

7.- INDICADORES DE CARGA DE BATERÍA + HORAMETROS CURTIS

2026

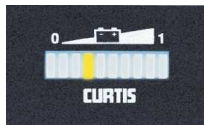

Ref.	Artículo	P.V.P.
HORAMETRO + INDICADOR DESCARGA BATERIA		
803RB12	IND.BAT./ HORAMETRO C/CORTE 12V	244,00
803RB2448	IND.BAT./ HORAMETRO C/CORTE 24/48V	190,00
803RB7280	IND.BAT./ HORAMETRO C/CORTE 72/80V	244,00
840R015RSNA101	DISPLAY 3 LEDS x variadores CURTIS	126,00
840R015RSNA102	DISPLAY 6 LEDS x variadores CURTIS	139,00

INDICADORES DE DESCARGA DE BATERIA		
906T24BNMAO	IND.BATERIA 24V HEXAGONAL SIN CORTE	102,00
906T36BNMAO	IND.BATERIA 36V HEXAGONAL SIN CORTE	102,00
906T48BNMAO	IND.BATERIA 48V HEXAGONAL SIN CORTE	102,00

INDICADORES DE DOBLE FUNCIÓN + RELOJ 12-48V.		
3002R56N	IND.DESC.BATERIA + MANTENIMIENTO	267,00
3002R57N	IND.DESC.BATERIA + HORAMETRO	161,00
3002R58N	IND.DESC.BATERIA + HORAMETRO PROGR.	226,00
3002R67N	MANTENIMIENTO + HORAMETRO	160,00

DISPLAY para 1212 / 1210 /1228		
ICE914Z-2401	DISPLAY CURTIS 24V tri-color 40,6x27,5mm	54,00
ICE934Z-2401	DISPLAY CURTIS 24V LCD 40,6x27,5mm	74,00
2114Z24	VOLTIMETRO 24V Ø52mm para PMC1228	74,00

EXTRAS VARIOS para indicadores		
4313100	ANILLO REDUCTOR Ø60mm a Ø52mm	12,00
13210001	TAPA PROTECCION INDICADORES CURTIS	24,00
15147004	KIT CONECTOR CURTIS 803	19,00

DISPLAY multifunción

909R3648BBN	Indicador 36-48V + puerto USB 5V 2A +Retroiluminación + Alarma nivel batería 20%	194,00
909R3648BBO	Indicador 36-48V + puerto USB 5V 2A +logo Curtis +Retroiluminación + Alarma nivel batería 20%	194,00
3100R-BNN-0001	Display LCD 12-48V CAN, 7 segment	121,00
3100R-BBN-0001	Display LCD 12-48V CAN, 7 segment, 2 botons	121,00
3140R2448HN002	Display LCD 24-48V CAN, 16 segment, no resistor	111,00
3140R2448HN103	Display LCD 24-48V CAN, 16 segment, 250Kbaud resistor	111,00
3150R1248DNN0	Display color LCD 12-48V CAN, serial & IO	121,00
3701P-1248	Display PCB de empotrar 5.7" Engage VII 12-48V CAN con multiples funciones programables	1.106,00
3701T-1248	Display modular 5.7" Engage VII 12-48V CAN con multiples funciones programables	1.281,00



Ref.	Artículo	P.V.P.
HORAMETROS		
701RND1248	HORAMETRO REDONDO 12-48V	42,00
701RND48150	HORAMETRO REDONDO 48-150V	42,00
701RRD1248	HORAMETRO RED.12-48V PUESTA CERO	42,00
701RRD48150	HORAMETRO RED.48-150V PUESTA CERO	42,00
701TND1248	HORAMETRO HEXAGONAL 12-48V	42,00
701TRD1248	HORAMETRO RECT.12-48V PUESTA CERO	42,00
701DRD1248	HORAMETRO DIN 12-48V	42,00
703TR1248	CONTADOR DE IMPULSOS 12-48V.	42,00

Llave teclado electrónico para accesos		
18442067	ECS Teclado 12-96V hasta 99 códigos IP65, 2 llaves + 1 tarjeta	221,00

Convertidores de pequeño formato para USB		
1415E-002	Convertidor 12-24V a 5V 2,1A + puerto USB	74,00
1415E-001	Convertidor 36-80V a 5V 2,1A + puerto USB	74,00
1415E-003	Convertidor 36-80V a 12V 1A	74,00

CONVERTIDORES DE TENSION		
1420E-0001	Convertidor 300W 24/80V salida 12,4V	280,00
1420E-0002	Convertidor 300W 24/80V salida 13,7V	280,00
1420E-0003	Convertidor 300W 24/80V salida 24V	280,00
1420E-0009	Convertidor 300W 24/80V salida 24V +enable	280,00
66127082	Kit conector 4 vías + Pins	14,50
1450-1110	Convertidor 500W 36/96V salida 12V +enable	330,00
1450-1210	Convertidor 500W 36/96V salida 13,5V +enable	330,00
1450-2110	Convertidor 500W 36/96V salida 24V +enable	330,00
1450-2210	Convertidor 500W 36/96V salida 27V +enable	330,00
1867104	Kit conectores Deutch & APTIV Metri-Pack 630	40,00

ACCELERADORES		
ET140	ACELERADOR TIMON CURTIS (equiv.ET109A)	214,00
ET126	ACELERADOR TIMON CURTIS (equiv.ET103)	214,00
PB-8	ACELERADOR RESISTIVO 5K+SW	254,00
17679700-0001	ACELERADOR WIGWAG 5K 20Ncm	103,00

FP-SMV	Pedal acelerador metálico suspendido	239,00
FP-SCV	Pedal acelerador suspendido	194,00
FP-FCV-0021	Pedal acelerador suelo superficie	194,00
FP-FCV-0047	Pedal acelerador suelo superficie	239,00
FP-LCV	Pedal acelerador suelo a empotrar	347,00
FP-10	Pedal ac.0-5kOhm Dual Spring 1m cable IP66	220,00
FP-6E	Pedal ac.0-5kOhm Dual Spring 1m cable IP66	233,00
FP-6way-Metri	Conector 6 vías para FP Curtis	30,00



7.-VARIADORES ELECTRONICOS CURTIS

2026



PMC1313k-4331	Programador Manual variadores CURTIS	888,00
PMC1309	PROGRAMADOR para PC -Cable Interface USB	583,00

Variadores con microprocesador motores Imanes Permanentes, opción CAN

1228-2430	VARIADOR 24V 70A (1 minuto) (35A 1h)	279,00
1228-2730	VARIADOR 24V 110A 15 sec.(75A 1 minuto) (35A 1h)	329,00
1228-2901	VARIADOR 24V 110A (1 minuto) (40A 1h)	368,00
1228-3430	VARIADOR 36V 70A (1 minuto) NILFISK	415,00

1212-2201	VARIADOR 24V 45A (Boost 55A 10 sec.)	137,00
1212-2401	VARIADOR 24V 70A (Boost 80A 10 sec.)	156,00

1212E-2501	VARIADOR 24V 90A 10 sec.(50A 2 min.) EN-ISO 13849-1:2015 & EN1175:2020 PL=d	250,00
------------	---	--------

1212S-2501	VARIADOR 24V 90A (Boost 100A 5 sec.)	250,00
1212S-2601	VARIADOR 24V 110A (Boost 125A 10 sec.)	296,00

1212C-2501	VARIADOR 24V 90A 20sec. (Boost 100A 5 sec.)	276,00
1212P-2501	VARIADOR 24V 90A 10 sec.	234,00

1229-3101	VARIADOR 24/36V 200A (2 min.) CAN	567,00
1229-3201	VARIADOR 24/36V 250A (2 min.) CAN	599,00
1229-4101	VARIADOR 48V 200A (2 min.) CAN	687,00

1220E-5401	VARIADOR 36/48V 60A (1min) CAN Motor Direcc	589,00
------------	---	--------

Variador MOTORES BLDC opción CAN

1226BL-2201	VARIADOR 24V 130A 1 min. (Boost 150A 10 sec.)	284,00
1226BL-4101	VARIADOR 36/48V 90A 1 min. (Boost 120A 10 sec.)	302,00
1226BL-4151	VARIADOR 36/48V 90A 1 min. (Boost 120A) CAN	359,00
1226BL-6151	VARIADOR 72V 70A 1 min. (Boost 80A) CAN, ext.relay	359,00

Variadores MOTORES EXCITACION SERIE

1204M-5301	VARIADOR 36/48V 325A	796,00
1205M-5601	VARIADOR 36/48V 500A	1.007,00
1209M-5501	VARIADOR 36/48V 450A	1.359,00
1221M-6701	VARIADOR 48/72V 550A	1.416,00

Variadores con MICROPROCESADOR

1207B-4118	VARIADOR 24V 250A	670,00
------------	-------------------	--------

Variadores MOTORES SEPEX

1243-2420	VARIADOR 24V 350A	1.014,00
1243-4220	VARIADOR 24/36V 200A	719,00
1243-4221	VARIADOR 24/36V 200A	829,00
1266A-5201	VARIADOR 36/48V 275A	660,00
1244-4461	VARIADOR 24/36V 400A	1.168,00
1244-5461	VARIADOR 36/48V 400A	1.168,00
1244-5561	VARIADOR 36/48V 500A	1.459,00
1244-5651	VARIADOR 36/48V 600A	1.754,00
1244-6561	VARIADOR 48/84V 500A	1.460,00
1244-6661	VARIADOR 48/84V 600A	1.754,00
1268-5403	VARIADOR 36/48V 400A	1.119,00
1268-5501	VARIADOR 36/48V 500A	1.346,00

Variadores para motores AC PMAC IPM, Flux Vector control

Variadores MOTORES AC / PMAC / IPM

1232E-2121	VARIADOR 24V 180A (90A)	585
1232E-2321	VARIADOR 24V 250A (125A)	674
1232E-5121	VARIADOR 36-48V 150A (75A)	695
1232E-5221	VARIADOR 36-48V 200A (100A)	726
1232E-6221	VARIADOR 48-80V 175A (80A)	837
1232E-7221	VARIADOR 72-96V 175A (80A)	880
1234E-2321	VARIADOR 24V 350A (175A)	876
1234E-5221	VARIADOR 36-48V 275A (140A)	1.000
1234E-5321	VARIADOR 36-48V 350A (175A)	1.048
1234E-6221	VARIADOR 48-80V 250A (110A)	1.181
1236E-4421	VARIADOR 24-36V 400A (175A)	1.325
1236E-4521	VARIADOR 24-36V 500A (240A)	1.378
1236E-5421	VARIADOR 36-48V 450A (205A)	1.421
1236E-5521	VARIADOR 36-48V 550A (250A)	1.699
1236E-6421	VARIADOR 48-80V 350A=1 minuto (100A)	1.645
1238E-4621	VARIADOR 24-36V 650A (300A)	2.098
1238E-4821	VARIADOR 24-36V 800A (355A)	2.372
1238E-5621	VARIADOR 36-48V 650A (295A)	2.181
1238E-6421	VARIADOR 48-80V 450A (155A)	2.328
1238E-6521	VARIADOR 48-80V 550A (190A)	2.245
1238E-6621	VARIADOR 48-80V 650A=1 minuto (195A)	2.727
1238E-7521	VARIADOR 72-96V 550A (175A)	3.392
1238E-7621	VARIADOR 72-96V 650A (200A)	3.891
1239E-6521	VARIADOR 60-84V 550A (155A)	2.745
1239E-7621	VARIADOR 72-108V 650A (190A)	3.321
1239E-8521	VARIADOR 72-144V 500A (135A)	4.035

SE SERIES

Variadores MOTORES AC / PMAC / IPM

1232SE-2471	VARIADOR 24V 375A (185A)	808
1232SE-5371	VARIADOR 36-48V 350A (175A)	880
1232SE-6371	VARIADOR 48-80V 250A (145A)	1.027
1234SE-4571	VARIADOR 24-36V 500A (235A)	1.184
1234SE-5471	VARIADOR 36-48V 450A (215A)	1.184
1234SE-6371	VARIADOR 48-80V 350A (150A)	1.373
1236SE-4671	VARIADOR 24-36V 650A (285A)	1.574
1236SE-5671	VARIADOR 36-48V 600A (260A)	1.736
1236SE-6571	VARIADOR 48-80V 450A (185A)	1.810
1238SE-4971	VARIADOR 24-36V 1000A (425A)	2.477
1238SE-5971	VARIADOR 36-48V 900A (395A)	2.636
1238SE-6971	VARIADOR 48-80V 900A (305A)	2.648
1238SE-7971	VARIADOR 72-96V 900A (305A)	2.748
1222-5101	VARIADOR 24-48V 70A special posicionamiento	667
1222-6101	VARIADOR 72-80V 70A special posicionamiento	704
1298-2201	VARIADOR 24V 250/300A combi tracción+bomba DC	1.012
1298-2301	VARIADOR 24V 300/350A combi tracción+bomba DC	1.105
PMC1313k-4331	Programador Manual variadores CURTIS	888,00
PMC1309	PROGRAMADOR para PC -Cable Interface USB	583,00

Variadores AC / PMAC / IPM / BLDC Flux Vector control



F2 medidas 155x120x55mm



F4 medidas 180x140x75mm



F6 medidas 212x155x78mm



F10 medidas 230x200x94mm



Variadores MOTORES AC / PMAC / IPM

F2-A-24-120-001	VARIADOR 24V 120A (120A)	382
F2-A-24-120-051	VARIADOR 24V 120A (120A) CAN interna 120Ω	382
F2-A-24-200-001	VARIADOR 24V 200A (150A)	411
F2-A-24-200-051	VARIADOR 24V 200A (150A) CAN interna 120Ω	411
F2-A-24-240-001	VARIADOR 24V 240A (150A)	445
F2-A-24-240-051	VARIADOR 24V 240A (150A) CAN interna 120Ω	445
F2-A-24-280-001	VARIADOR 24V 280A (130A)	494
F2-A-24-280-051	VARIADOR 24V 280A (130A) CAN interna 120Ω	494
F2-A-48-150-001	VARIADOR 36-48V 150A (130A)	557
F2-A-48-150-051	VARIADOR 36-48V 150A (130A) CAN interna 120Ω	557
F2-A-48-240-001	VARIADOR 36-48V 240A (140A)	744
F2-A-48-240-051	VARIADOR 36-48V 240A (140A) CAN interna 120Ω	744
F4-A-24-375-001	VARIADOR 24V 375A (290A)	761
F4-A-24-375-101	VARIADOR 24V 375A (290A) IMU+CAN aislado	806
F4-A-36-500-001	VARIADOR 24-36V 500A (245A)	
F4-A-48-350-001	VARIADOR 36-48V 350A (205A)	898
F4-A-48-375-001	VARIADOR 36-48V 375A (210A)	902
F4-A-48-375-101	VARIADOR 36-48V 375A (210A) IMU+CAN aislado	948
F4-A-48-450-001	VARIADOR 36-48V 450A (210A)	1.089
F4-A-48-450-101	VARIADOR 36-48V 450A (210A) IMU+CAN aislado	1.134
F4-A-80-220-201	VARIADOR 48-80V 220A (151A) CAN aislado	1.112
F4-A-80-300-001	VARIADOR 48-80V 300A (140A)	1.027
F4-A-80-300-101	VARIADOR 48-80V 300A (140A) IMU+CAN aislado	1.077
F4-A-96-150-101	VARIADOR 72-96V 150A (140A) IMU+CAN aislado	1.110
F4-A-96-300-101	VARIADOR 72-96V 300A (135A) IMU+CAN aislado	1.316
F6-A-36-650-001	VARIADOR 24-36V 650A (265A)	1.419
F6-A-36-650-101	VARIADOR 24-36V 650A (265A) IMU+CAN aislado	1.469
F6-A-48-650-001	VARIADOR 36-48V 650A (240A)	1.483
F6-A-48-650-101	VARIADOR 36-48V 650A (240A) IMU+CAN aislado	1.531
F6-A-80-450-001	VARIADOR 48-80V 450A (175A)	1.531
F6-A-80-450-101	VARIADOR 48-80V 450A (175A) IMU+CAN aislado	1.578
F6-A-96-450-101	VARIADOR 72-96V 450A (175A) IMU+CAN aislado	1.636
F10-A-36-650-101	VARIADOR 24-36V 650A (370A) IMU+CAN aislado	1.668
F10-A-36-1000-101	VARIADOR 24-36V 1000A (440A) IMU+CAN aislado	2.439
F10-A-48-650-101	VARIADOR 36-48V 650A (370A) IMU+CAN aislado	
F10-A-48-800-101	VARIADOR 36-48V 800A (390A) IMU+CAN aislado	
F10-A-48-1000-101	VARIADOR 36-48V 1000A (440A) IMU+CAN aislado	2.520
F10-A-80-550-101	VARIADOR 60-80V 550A (260A) IMU+CAN aislado	2.251
F10-A-80-650-101	VARIADOR 60-80V 650A (280A) IMU+CAN aislado	
F10-A-80-750-101	VARIADOR 60-80V 750A (325A) IMU+CAN aislado	2.310
F10-A-96-650-101	VARIADOR 72-96V 650A (290A) IMU+CAN aislado	2.529
F10-AF-96-650-20	VARIADOR 72-96V 650A (325A) CAN aislado	2.708

Variadores AC Dual Motor Traction

F2-D-24-120-151	VARIADOR 24V 2x 120A (2x 48A) IMU	761
F2-D-24-200-151	VARIADOR 24V 2x 200A (2x 80A) IMU	826
F2-D-48-120-151	VARIADOR 48V 2x 120A (2x 48A) IMU	971
F2-D-48-240-151	VARIADOR 48V 2x 240A (2x 94A) IMU	1.165
F5-DE-48-350-201	VARIADOR 48V 2x 350A (2x 140A)	1.480
F5-DE-48-450-201	VARIADOR 48V 2x 450A (2x 160A)	1.582
F5-DE-48-450-401	VARIADOR 48V 2x 450A (2x 160A) Resolver	1.605
F5-DE-80-400-201	VARIADOR 80V 2x 400A (2x 150A)	1.820
F5-DE-80-400-401	VARIADOR 80V 2x 400A (2x 150A) Rseolver	1.910

Variadores AC / PMAC / IPM / BLDC Flux Vector control



F2-T & F2-D medidas 206x150x71mm



F2-C medidas 200x120x59mm



Variadores AC Dual Motor Traction & DC Pump

F2-T 24-120-240-001	VARIADOR 24V 2x 120A (2x 48A) +Bomba 240A	889
F2-T 24-120-280-001	VARIADOR 24V 2x 120A (2x 48A) +Bomba 280A STD	889
F2-T 24-200-280-001	VARIADOR 24V 2x 200A (2x 80A) +Bomba 280A	939
F2-T 24-200-280-151	VARIADOR 24V 2x 200A (2x 80A) +Bomba 280A PLT IMU	971
F2-T 48-120-240-151	VARIADOR 48V 2x 120A (2x 48A) +Bomba 240A PLT IMU	1.101
F2-T 48-240-240-151	VARIADOR 48V 2x 240A (2x 94A) +Bomba 240A PLT IMU	1.278

Variadores Combi AC Traction & Pump DC

F2-C-24-120-200-001	VARIADOR 24V 120A (42A) +Bomba 200A	552
F2-C-24-200-200-001	VARIADOR 24V 200A (70A) +Bomba 200A	585
F2-C-24-240-280-001	VARIADOR 24V 240A (84A) +Bomba 280A	630
F2-C-24-280-300-001	VARIADOR 24V 280A (98A) +Bomba 300A	679
F2-C-48-150-200-001	VARIADOR 36-48V 150A (53A) +Bomba 200A	647
F2-C-48-240-240-001	VARIADOR 36-48V 240A (84A) +Bomba 240A	789

CIT-D-4301	Software CURTIS para serie F, OEM-Dealer	1.055,00
CIT-D-4401	Software CURTIS para serie F, OEM-Factory	1.055,00

Módulos auxiliares CAN

1360-01	CAN isolator	127
1351-5001	Módulo CANbus con VCL 12-48V 25 I/O	522
1351-7001	Módulo CANbus con VCL 36-96V 25 I/O	541
1352-4001	Módulo CANbus 12-36V 9 outputs	246
1352-6001	Módulo CANbus 36-80V 9 outputs	279
1353-4101	Módulo PLUS CANbus 12-36V 15 outputs +++	315
1353-6101	Módulo PLUS CANbus 36-80V 15 outputs +++	350

Variadores AC 400V para motores AC y PMAC hasta 100kW

Control por par y velocidad

Programable via CANbus

F5-R-400-200	150-525V 200A (100A 2 minut) Liquid Coled	4.280,00
F5-R-400-300	150-525V 300A (150A 2 minut) Liquid Coled	4.920,00

Displays LCD

3100R-BNN-0001	Display LCD 12-48V CAN, 7 segment	121,00
3100R-BBN-0001	Display LCD 12-48V CAN, 7 segment, 2 botons	121,00
3140R2448HN002	Display LCD 24-48V CAN, 16 segment, no resistor	111,00
3140R2448HN103	Display LCD 24-48V CAN, 16 segment, 250Kbaud resistor	111,00
3150R1248DNN0	Display color LCD 12-48V CAN, serial & IO	121,00
3701P-1248	Display PCB de empotrar 5.7" Engage VII 12-48V CAN con multiples funciones programables	consultar
3701T-1248	Display modular 5.7" Engage VII 12-48V CAN con multiples funciones programables	consultar

11.- MOTORES PMAC - opciones freno IP44 y IP67, eje saliente, múltiples ejes y bridas adaptadoras

2026



Motor 132-52 3,6kW 30Nm

P.Neto

2019-002-079	132-52 B14-80 eje 19mm	1.024
2019-002-066	132-52 B5-80 eje 19mm	1.178
2019-002-071	132-52 SAE A Z9	1.222
2019-002-082	132-52 Group 1	1.136



Motor 193-40 5,5kW 70Nm

P.Neto

2019-002-079	193-40-18A+No Shaft	1.440
2019-002-066	193-40-18A+ 19mm keyed shaft	1.490
2019-002-071	193-40-18A+ SAE A 9T pump interface	1.564
2019-002-082	193-40-18A+SAE B 13T pump interface	1.564
2019-002-069	193-40-18A+E-Axle 1*	1.564
2019-002-114	193-40-18A+B14-100	1.564
2019-002-112	193-40-18A+B5-100	1.600



Motor 193-80 10kW 140Nm

P.Neto

2019-002-080	193-80-10A+No shaft	1.824
2019-002-081	193-80-13A+No shaft	1.824
2019-002-065	193-80-10A+ 24mm keyed shaft	1.872
2019-002-078	193-80-13A+ 24mm keyed shaft	1.872
2019-002-083	193-80-10A+ SAE A 9T pump interface	1.974
2019-002-072	193-80-13A+ SAE A 9T pump interface	1.974
2019-002-084	193-80-10A+SAE B 13T pump interface	1.974
2019-002-085	193-80-13A+SAE B 13T pump interface	1.974
2019-002-064	193-80-10A+E-Axle 1*	1.974
2019-002-077	193-80-13A+E-Axle 1*	1.974
2019-002-113	193-80-10A+B14-100	1.974
2019-002-111	193-80-13A+B14-100	1.974
2019-002-121	193-80-10A+B5-100	2.000
2019-002-122	193-80-13A+B5-100	2.000



Motor 193-120 15kW 210Nm **AVAILABLE MAY 2026**

P.Neto

2019-002-138	193-120-10A+ 24mm keyed shaft	2.450
2019-002-161	193-120-10A+ 24mm keyed shaft B14-100	2.656
2019-002-162	193-120-10A+ 24mm keyed shaft B5-100	2.726

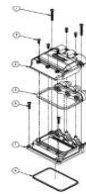

Tapa protectora bornes

2013-103-010	132 Series Terminal cover kit	26
2019-103-001	193-40 11.0mm SEAL(Cable exit can be oriented towards drive	26
2019-103-002	193-80 11.0mm SEAL (Cable exit towards drive end)	26
2019-103-003	193-80 11.0mm SEAL (Cable exit towards non drive end)	26

Bridas adaptadoras (MOQ 5 piezas)

2019-101-111	Adapter Plate, SAE A	116
2019-101-106	Adapter Plate, SAE B	116
2019-101-103	Adapter Plate, E-Axle 1	116
2019-101-114	Adapter Plate, B14/100	116
2019-101-112	Adapter Plate, B5/100	148



9T spline shaft with SAE-A



13T spline shaft with SAE-B



19T spline shaft with H12/24E/30E-Axle



3.- VARIADORES, CONVERTIDORES SEVCON

2025

Variadores 24-150V para motores asíncrono y síncrono, Flux Vector control

Ref.	Artículo	P.V.P.
VARIADORES PARA MOTORES AC y PMAC		
634A23206	Gen4 24-36V 300A CANopen	867,00
634A34206	Gen4 24-36V 450A CANopen	1.317,00
634A36203	Gen4 24-36V 650A CANopen	1.675,00
634A42206	Gen4 36-48V 275A CANopen	890,00
634A44206	Gen4 36-48V 450A CANopen	1.317,00
634A46203	Gen4 36-48V 650A CANopen	1.675,00
634A81206	Gen4 72-80V 180A CANopen	1.069,00
634A83223	Gen4 72-80V 350A CANopen	1.577,00
634A85203	Gen4 72-80V 550A CANopen	2.045,00
634A9xxxx	Gen4 96-120V 150A CANopen	consultar
634A13202	Gen4 96-120V 300A CANopen	1.906,00
634A9xxxx	Gen4 96-120V 450A CANopen	consultar
60460015	DISPLAY Smartview SEVCON Ø52mm	226,00
60490010	DISPLAY CLEARVIEW SEVCON AC CAN	777,00
66214050	CALIBRADOR MANUAL variadores AC CAN	1.040,00
VARIADORES PARA MOTORES AC - Corriente Alterna		
634N2440	Nano 24V 400A CANopen	consultar
634N4825	Nano 48V 250A CANopen	consultar
634N2425-P30	Nano 24V 250A + Bomba 24V.dc 300A	consultar

Variadores 200-800V para motores asíncrono y síncrono, Flux Vector control

Variadores AC para control de implementos, bombas, ventiladores en autobuses eléctricos, maquinaria agrícola, tractores y otras vehíc 4 entradas analógicas 0-10V, 4 entradas digitales, 2 salidas 5-10V (100mA y 200mA), 2 salidas digitales		
634L10201	200-800V 19A (24A 1 minut) Air Colled HVLP10	2.300,00
634L20201	200-800V 33A (53A 1 minut) Liquid Colled HVLP10	2.400,00
18422145	HVA280 Power Harness 4m Key A Bateria	450,00
18422155	HVA280 Power Harness 4m Key B Motor	450,00
VARIADORES PARA MOTORES AC y PMAC		
634H83204	Gen4 Size 8 128-400V 400A CANOpen	5.950,00
VARIADORES PARA MOTORES AC y PMAC		
634A34901	Gen5 Size 9 128-450V 400A CANOpen	6.150,00
VARIADORES PARA MOTORES AC y PMAC		
634Axxxx	Gen4 Size10 50-800V 400A CANOpen	11.450,00

DISTRIBUIDOR OFICIAL





Ref.	Artículo	P.V.P.
VARIOS SEVCON		
60415003	DISPLAY SEVCON	439,00
60415006	DISPLAY NISSAN	439,00
60460001	DISPLAY SC2000 (EQ.60468001)	762,30
60460015	DISPLAY SEVCON Ø52mm para HAULOTTE	225,20
66611700	MODULO HAULOTTE HA12IP ref.2441605640	690,00
90020032	Ind.Desc.Batería + Horámetro 24-80V con corte	240,00
66214030	CALIBRADOR SC2000 / PowerpaK / MicropaK	763,00
66214001	CALIBRADOR MOS90	630,00
66214039	CALIBRADOR PC-Pak PowerpaK / MicropaK incluye cable interface + CD software OEM	665,00



VARIADORES POWERPAK - MICROPAK		
632P44531	VARIADOR BOMBA 24/48V 450A	832,00
632P46526	VARIADOR BOMBA 48V 650A (CLARCK)	1.715,00
632P46530	VARIADOR BOMBA 48V 650A (TAILIFT)	1.588,00
632P84521	VARIADOR BOMBA 72/80V 450A	1.850,00
632P86521	VARIADOR BOMBA 72/80V 600A	1.990,00
632T44221	VARIADOR TRACCION 24/48V 450A	1.200,00
632T46221	VARIADOR TRACCION 24/48V 650A	1.755,00
632T46213	VARIADOR TRACCION 24/48V 650A (TOYOTA)	1.755,00
632T84221	VARIADOR TRACCION 72/80V 450A	1.450,00
632T86221	VARIADOR TRACCION 72/80V 600A	1.995,00
632S43611	VARIADOR SEM 24/48V 350A	1.444,00
632S45650	VARIADOR SEM 24/48V 500A	1.440,00
632S45651	VARIADOR SEM 24/48V (JLG)=632S45616	1.440,00
632S45660	VARIADOR SEM 24/48V (HAULOTTE)=632S45623	1.440,00
632S45654	VARIADOR SEM 500A 48V (MANITOU)=632S45627	1.440,00
632S84622	VARIADOR SEM 80V (COMBILIFT)=632S84614	1.945,00
632S84623	VARIADOR SEM 24/48V (LUGLI)	1.945,00



VARIADORES MICROPAK y MILLIPAK		
632M42102	MICROPAK SEM 24/48V (TCM bimotor)	1.040,00
632M42115	MICROPAK SEM 24/48V (NISSAN ref.293203G401)	924,00
PROA70481	MILLIPAK SEM especial JLG n°1600346	982,00
633T46103	MILLIPAK SEM Traccion 24V 600A (Hyster-Yale)	1.315,00
633T46503	MILLIPAK SEM Bomba 24-48V 600A	1.355,00

25.-VARIADORES ELECTRONICOS para Motores BLDC y PMAC

2026



Ref.	Artículo	P.V.P.
Low Power Brushless DC motors 1 y 2 canales		
SBL1360A	60V 30A 1 canal, Trapez/Sin,8xDig/An IO,USB,CAN, sin tapa	369,00
SBLMG1360T	60V 30A 1 canal, Molex, Trapez/Sin,8xDig/An IO,USB,CAN, sin	528,00
SBLG2360T	60V 2x30A 2 canal,Trapez/Sin,14xDig/An IO,USB,CAN, STO	721,00
SBLG2360TS	60V 60A 1 canal,Trapez/Sin,14xDig/An IO,USB,CAN, STO	721,00
SBLMG2360T	60V 2x30A 2 canal,Trapez/Sin,14xDig/An IO,USB,CAN, STO	787,00
SBLMG2360TS	60V 60A 1 canal,Trapez/Sin,14xDig/An IO,USB,CAN,STO	787,00
SBLM2360T	60V 2x30A 2 canal,Trapez/Sin,14xDig/An IO,USB,CAN, STO	754,00
SBLM2360TS	60V 60A 1 canal,Trapez/Sin,14xDig/An IO,USB,CAN,STO	754,00
Mid Power Brushless DC motors 1 y 2 canales		
MBL1660A	60V 120A 1 canal, Trapez/Sin,8xDig/An IO,USB,CAN, tapa	567,00
KBL1660	60V 120A 1 canal, Trapez/Sin,8xDig/An IO,USB,CAN, tapa	759,00
FBLG2360T	60V 2x60A 2 canales, Trapez/Sin,8xDig/An IO,USB,CAN, STO	1.007,00
FBLG2360TS	60V 120A 1 canal, Trapez/Sin,14xDig/An IO, Resolver/SSI,STO, CAN	1.007,00
FBLG2360TE	60V 2x60A 2 canales, Trapez/Sin,14xDig/An IO, Resolver/SSI,STO,USE	1.100,00
FBLG2360TES	60V 120A 1 canal, Trapez/Sin,14xDig/An IO, Resolver/SSI,STO,USB,C	1.100,00
High Power Brushless DC motors 1 y 2 canales		
GBLG2660T	60V 2x180A 2 canales, Hall, Encoder,USB,CAN, STO	1.375,00
GBL2660TS	60V 360A 1 canal, Hall, Encoder,USB,CAN, STO	1.375,00
GBL2660TE	60V 2x180A 2 canales, Hall, Encoder,USB,CAN, Ethernet, STC	1.496,00
GBL2660TES	60V 360A 1 canal, Hall, Encoder,USB,CAN, Ethernet, STO	1.496,00

25.-VARIADORES ELECTRONICOS para Motores Imanes Permanentes

2026



Low Power	Brushed DC motors 1 y 2 canales	
SDC2160S	60V 40A 1 canal,8xDig/An IO,USB,CAN	385,00
SDC2160	60V 2x20A 1 canal,8xDig/An IO,USB,CAN	385,00
Mid Power	Brushed DC motors 1 y 2 canales	
MDC1460	60V 120A 1 canal,8xDig/An IO,USB,CAN	424,00
MDC2460	60V 2x60A 2 canales,8xDig/An IO,USB,CAN	578,00
FDCG3260T	60V 3x60A 3 canales,14xDig/An IO,USB,CAN, STO	1.007,00
FDCG3260TE	60V 3x60A 3 canales,14xDig/An IO,USB,CAN, STO, Ethernet	1.100,00
High Power	Brushed DC motors 1 y 2 canales	
HDC2460S	60V 300A 1 canal, 19xDig/An IO,USB,CAN	836,00
HDC2460	60V 2x150A 2 canales, 19xDig/An IO,USB,CAN	836,00
V.High Power	Brushed DC motors 1 y 2 canales	
RGD1860	60V 300A 1 canal,16xDig/An IO,USB,CAN	1.200,00
GDCG3660T	60V 3x 180A 3 canales,16xDig/An IO,USB,CAN	1.375,00
GDCG3660E	60V 3x 180 3 canales,16xDig/An IO,USB,CAN, Ethernet	1.496,00

25.-VARIADORES ELECTRONICOS para Motores AC inducción

2026



Ref.	Artículo	P.V.P.
Low Power	AC induction motors 1 y 2 canales	
SIM1360	60V 30A 1 canal,6xDig/An IO,USB,CAN	367,00
SIMG2360TS	60V 60A 1 canal,6xDig/An IO,USB,CAN, STO, SIL3	721,00
SIMG2360T	60V 60A 2X 30A 2 canales,6xDig/An IO,USB,CAN, STO, SIL3	721,00
Mid Power	AC induction motors 1 y 2 canales	
FIMG2360TS	60V 120A 1 canal,14xDig/An IO,USB,CAN,STO	1.007,00
FIMG2360T	60V 2x60A 2 canales,14xDig/An IO,USB,CAN,STO	1.007,00
FIMG2360TES	60V 120A 1 canal,14xDig/An IO,USB,CAN,STO, Ethernet	1.100,00
FIMG2360TE	60V 2x60A 2 canales,14xDig/An IO,USB,CAN,STO,Ethernet	1.100,00
V.High Power	AC induction motors 1 y 2 canales	
RGIM1860	60V 300A 1 canal, Encoder I,16xDig/An IO,USB,CAN	1.250,00
GIMG2660T	60V 2x 180A 2 canales, Encoder I,16xDig/An IO,USB,CAN	1.375,00
GIMG2660TS	60V 360A 1 canal, Encoder I,16xDig/An IO,USB,CAN	1.375,00
GIMG2660TE	60V 2x 180A 2 canales, Encoder I,16xDig/An IO,CAN,Ethernet	1.496,00
GIMG2660TES	60V 360A 2 canales, Encoder I,16xDig/An IO,CAN,Ethernet	1.496,00

25.-SENSORES, CINTAS, ADAPTADORES, CONECTORES & BMS

2026

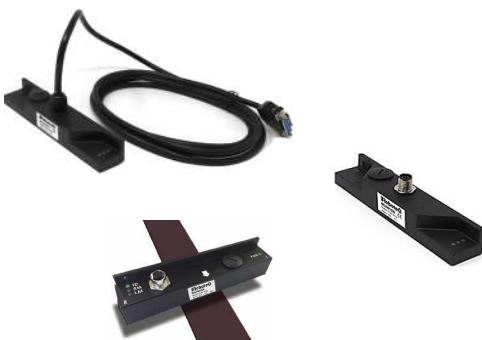

Ref.	Artículo	P.V.P.
Sensores magnéticos y ópticos		
MGS1600	Sensor Magnético 160mm,2m cable,ABS,serial,USB, PWM,CAN	567,00
MGSM1600	Sensor Magnético 160mm, M12, ABS, serial, USB, PWM & CAN	770,00
MGSW1600	Sensor Magnético 160mm, Metal, serial, USB, PWM & CAN	790,00
MGSW3200	Sensor Magnético 320mm, Metal, serial, USB, PWM & CAN	972,00
MGSW4800	Sensor Magnético 480mm, Metal, serial, USB, PWM & CAN	1.292,00

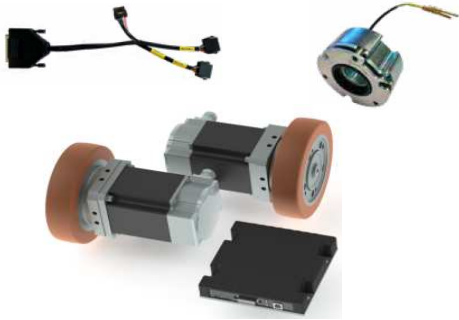

Ref.	Artículo	P.V.P.
Kit AGV 48V 600kgs con y sin Ethernet-Freno		
AGV089A03G	2 motores 089LDA300 + 2 reductoras VRLZ090 + 2 ruedas + 1x FBLG2360TE 2 canales 60A + Cableado	3.780,00
AGV089A04G	2 motores 089LDA300 + Freno + 2 reductoras VRLZ090 + 2 ruedas + 1x FBLG2360T 2 canales 60A + Cableado	4.110,00
AGV089A03E	2 motores 089LDA300 + 2 reductoras VRLZ090 + 2 ruedas + FBL2360TE 2 canales 60A +Cableado +Ethernet	3.840,00
AGV089A04E	2 motores 089LDA300+ Freno + 2 reductoras VRLZ090 + 2 ruedas + FBL2360TE 2x 60A +Cableado +Ethernet	4.170,00



Ref.	Artículo	P.V.P.
Carta para expansión		
RIOX-1216AH	I/O eXtender 3A DCDC 12In.16 Out.+AHS	330,00
SR5K100V25I	Shunt regulator 5kW 200W CO, 120V 2.5Ohm	308,00
USB-isolator	Full speed USB 2.0 compliant port isolator with a 1000V isolatio	114,00
Cintas magnéticas - MOQ 10 unidades -		
MTAPE25NR	Rollo 45,7m x 25,4mm. Sud. 6kgs	282,00
MTAPE50NR	Rollo 45,7m x 50,8mm. Sud. 11,4kgs	486,00
MAGMARKER25	Marcador de segmentos 2,54x30,5cm 1,1mm. Norte	3,90
MTAPENTOP25	Rollo 45,7m x 25,4mm.Norte. 6gs - MOQ 10 pcs	350,00
MTAPENTOP50	Rollo 45,7m x 50,8mm.Norte. 11,4gs - MOQ 10 pcs	550,00
MTAPEsquare5x5	Rollo 15,24m, 5x5mm para MGS1600	96,00
Line3IN-YL	Rollo linea amarilla 30,5m, ancho 76,2mm. Adesiva	288,00
Line4IN-YL	Rollo linea amarilla 30,5m, ancho 101,6mm. Adesiva	300,00
RTAPE25YL	Rollo cinta reflectante 25m, ancho 25mm. Adesiva	140,00
PCB's, Cables y Conectores para RoboteQ		
BOB15	Break-out board with DSub15M & DSub9F	40,00
BOB25F	Break-out board with DSub25M & DSub9F	40,00
CABLE-ABCX1	ABC Hall cable, Molex connector for BLDC controller	31,00
CABLE-ABCX1M	ABC Hall cable, JST connector for SBL1 controller	31,00
CABLE-ABCX2	ABC Hall cable, 2xMolex connector for 2channel BLDC controlle	31,00
CABLE-BOB15	Break-out board with DSub25M & DSub9F + cable RS232	42,00
CABLE-DS9	Cable 9pin D-Sub Macho/Hembra	31,00
CABLE-ENC1	Cable encoder y PCB para MDC2/XDC2	41,00
CABLE-RC2	Cable RC Radio x RoboteQ 15-pin connectors	31,00
CABLE-RC5	Cable RC Radio x RoboteQ 25-pin connectors	31,00
CABLE-RGBx1	Cable x RGBL/RGIM, 8-pin circular a 8 color-coded	45,00
CABLE-S_PWRC	Cable para voltage PwrCtl a controladores SDC/SBL	8,40

5.-VARIADORES ELECTRONICOS para Motores Imanes Permanentes **PG DRIVES**

2025

**Scooters
Triciclos**

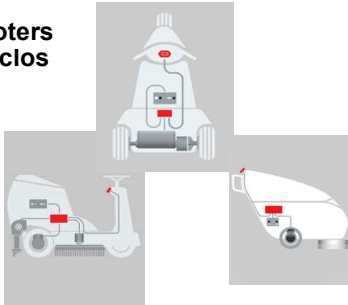

**Maquinaria limpieza industrial
(barredoras, fregadoras,...)**



**Sillas de
ruedas**

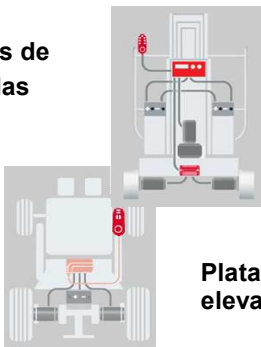

**Plataformas
elevadoras**

Ref.	Artículo	P.V.P.
D51266	Programador PC variadores PG DRIVES	520,00
D50338	Programador Manual EGIS/SOLO/S+I-DRIVE	702,00
D50032	DISPLAY Carga Batería 24V PCB Circuito Impr.	19,00
D50066	DISPLAY Carga Batería 24V	23,50
D50826	INDICADOR Carga Batería 24/36V	24,60

I-DRIVE Tamaño muy reducido, robusto, 3 salidas auxiliares		
D51400	VARIADOR I-DRIVE 24V 45A	115,00
D51401	VARIADOR I-DRIVE 24V 70A (D51767)	120,00
D51175	VARIADOR I-DRIVE 24V 140A	190,00
D51176	VARIADOR I-DRIVE 24V 180A	235,00
D51403	VARIADOR I-DRIVE 36V 70A (=D50969)	160,00
D51200	VARIADOR I-DRIVE 36V 140A	240,00
D51201	VARIADOR I-DRIVE 36V 180A	290,00
D50434	TAPA PROTECTORA I-DRIVE 45\70	7,50
D51160	TAPA PROTECTORA I-DRIVE 140\180	10,00
D50319	MOLEX Connector Kit	7,00

VR2 Control de 2 motores con joystick		
D51877	VARIADOR VR2 50A sin actuators	168,00
D51879	VARIADOR VR2 60A sin actuators	180,00
D50880	VARIADOR VR2 60A con 1 actuators	220,00
D50881	VARIADOR VR2 60A con 2 actuators	235,00
D51884	VARIADOR VR2 70A sin actuators	202,00
D50886	VARIADOR VR2 70A con 1 actuador	327,00
D50887	VARIADOR VR2 70A con 2 actuators	345,00
D51890	VARIADOR VR2 90A sin actuators	268,00
D51892	VARIADOR VR2 90A con 2 actuators	357,00
D51677	JOYSTICK VR2 +cable 1,2m	153,00
D50680	JOYSTICK VR2 +2 botones +cable 1,2m	197,00
D50681	JOYSTICK VR2 +Lights +2 botones +Y cable 1,2m	241,00
D50242	LIGHT CONTROL MODULE for VR2	85,00
x2 D50301	Connector Kit Light Control Module VR2 (1 unit)	5,10
x2 D50750	Connector Kit Motor VR2	4,80
D50751	Connector Kit Battery VR2	8,60
D50752	Connector Kit On board charger VR2	2,65
D50753	Connector Kit Inhibit VR2	2,65
D50754	Connector Kit Actuator VR2	2,65
D49712	Connector Kit Battery VR2 90A	7,00
D49713	Connector Kit Motor VR2 90A -kit of 2 units	15,00
D50427	PROGRAMADOR PC VR2 version OEM (D50145)	705,00

TRIO Control de 3 motores con un mismo variador		
D50214	VARIADOR TRIO+ 24V 50A	497,00
D50215	VARIADOR TRIO+ 24V 100A	542,20
D50216	VARIADOR TRIO+ 24V 150A	614,50
D49938	MODULO LCD PARA TRIO+	190,10
D50095	TRIO LCD Molex connector kit	20,50
D50191	TRIO Traction Motor connector kit 6-10mm ²	10,60
D50347	TRIO Brush Motor connector kit 6-10mm ²	8,00
D50026	TRIO Vacuum Motor connector kit 4-6mm ²	8,00
D50094	TRIO Molex connector kit	13,50

Variadores AC para motores asincrono, Slip control



C3 Autoconfigurable

Ref.	Artículo	P.V.P.
PARA MOTORES AC de pequeña potencia - Corriente Alterna		
C3		
D51260	VARIADOR C3 24V 200A	411,00
D51210	VARIADOR C3 24V 250A	488,00
D51371	VARIADOR C3 24V 200A CAN	425,00
D51372	VARIADOR C3 24V 250A CAN	502,00
D51388	VARIADOR C3 24V 200A + Bomba	565,00
D51379	VARIADOR C3 24V 250A + Bomba	644,00
D51248	C3 Connector Kit (all connectors)	33,00
D51264	C3 Power Connector Kit 5x AMP de crimpar	16,00
D50795	INDICADOR 52mm LCD C3 y iDrive 140/180A	128,00
D51044	Connector Kit iGauge C3 y iDrive 140/180A	10,00
D51265	Programador PC variadores C3	650,00



PARA MOTORES AC - Corriente Alterna		
SIGMADRIVE		
D51004	TRACCIÓN 24-48V 180A ACT425S	459
D51003	TRACCIÓN 24-48V 320A ACT445M	768
D51002	TRACCIÓN 24-48V 460A ACT465L	968
D51061	TRACCIÓN 72-80V 125A ACT817S	459
D51001	TRACCIÓN 72-80V 250A ACT835M	768
D51000	TRACCIÓN 72-80V 460A ACT865L	1.037
D51009	BOMBA 24-48V 180A ACP425S	459
D51008	BOMBA 24-48V 320A ACP445M	768
D51007	BOMBA 24-48V 460A ACP465L	968
D51063	BOMBA 72-80V 125A ACP817S	459
D51006	BOMBA 72-80V 250A ACP835M	768
D51005	BOMBA 72-80V 460A ACP865L	1.037
D51066	16 WAY Connector kit	19,30
D51067	6 WAY Connector kit	8,90
D51068	8 WAY Connector kit	8,00
D51027	SIGMADRIVE LCD VEHICLE DISPLAY	286
D51069	LCD 8 WAY Connector kit	8,00
D51026	PROGRAMADOR MANUAL SIGMADRIVE	574

11.- MOTORES ELÉCTRICOS DE CC Y CA CFR

2025

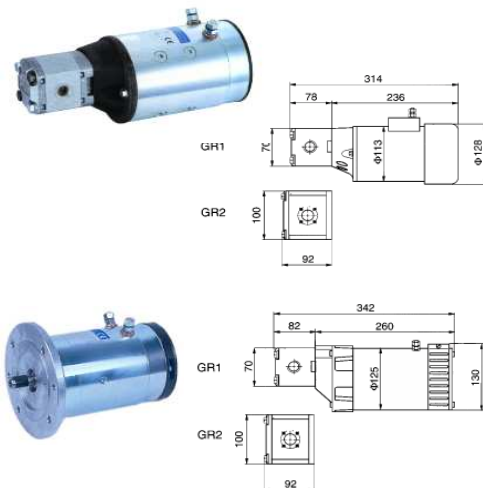

MOTORES SERVODIRECCIÓN CORRIENTE CONTINUA CFR		
		P.Netto
SE000	MOTOR SERVO 500W Ø113 12V	833,00
SE001	MOTOR SERVO 500W Ø113 24V	833,00
SE002	MOTOR SERVO 500W Ø113 36V	833,00
SE003	MOTOR SERVO 500W Ø113 48V	833,00
SE005	MOTOR SERVO 500W Ø113 72V	833,00
SE006	MOTOR SERVO 500W Ø113 80V	833,00
SE019	MOTOR SERVO 800W Ø125 24V	917,00
SE020	MOTOR SERVO 800W Ø125 36V	917,00
SE021	MOTOR SERVO 800W Ø125 48V	917,00
SE023	MOTOR SERVO 800W Ø125 72V	917,00
SE024	MOTOR SERVO 800W Ø125 80V	917,00

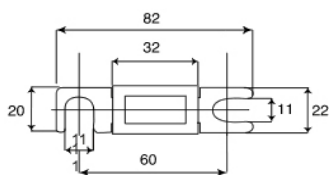

Ref.	Artículo	P.V.P.
PORTAFUSIBLES Y FUSIBLES DIN43562		
80271-06	Portafusible 2 Bornes M10x20 +tornillería	18,00
80272-06	Portafusible 2 Bornes M10x29 +tornillería	22,00
80271-01	Portafusible 1 Borne M8x20	9,00
85800035	FUSIBLE 35A PROTEGIDO 60mm	4,00
85800040	FUSIBLE 40A PROTEGIDO 60mm	4,00
85800050	FUSIBLE 50A PROTEGIDO 60mm	4,00
85800063	FUSIBLE 63A PROTEGIDO 60mm	4,00
85800080	FUSIBLE 80A PROTEGIDO 60mm	4,00
85800100	FUSIBLE 100A PROTEGIDO 60mm	4,00
85800125	FUSIBLE 125A PROTEGIDO 60mm	4,00
85800160	FUSIBLE 160A PROTEGIDO 60mm	4,00
85800200	FUSIBLE 200A PROTEGIDO 60mm	4,00
85800250	FUSIBLE 250A PROTEGIDO 60mm	5,00
85800300	FUSIBLE 300A PROTEGIDO 60mm	5,00
85800325	FUSIBLE 325A PROTEGIDO 60mm	5,00
85800355	FUSIBLE 355A PROTEGIDO	5,00
85800425	FUSIBLE 425A PROTEGIDO	5,00
85800500	FUSIBLE 500A PROTEGIDO	5,00

Fusibles típicos de MIC-JUNGHEINRICH

85700080	FUSIBLE MINI 80A PROTEGIDO DIN72581	4,00
85700100	FUSIBLE MINI 100A PROTEGIDO DIN72581	4,00
85700150	FUSIBLE MINI 150A PROTEGIDO DIN72581	4,00

8.- CONVERTIDORES CC/CC SEVCON

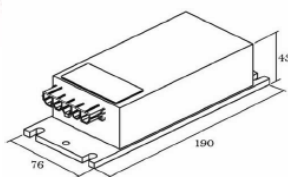

Protegidis contra cortocircuito, sobrecalentamiento e inversión de polaridad - Protección IP67 - medidas 190x76x43

62211083	CONVERTIDOR 200W 24/36V A 24V	324,29
62211100	CONVERTIDOR 300W 36/48V A 12V	280,00
62211085	CONVERTIDOR 300W 36/48V A 24V	280,00
62211086	CONVERTIDOR 300W 60/80V A 13V	280,00
62211087	CONVERTIDOR 300W 72/80V A 24V	280,00
62211095	CONVERTIDOR 300W 96V A 12V	324,29
62211096	CONVERTIDOR 300W 96V A 24V	324,29
62211089	CONVERTIDOR 200W 72/80V A 48V	324,29
62211091	CONVERTIDOR 200W 24/36V A 12V	324,29

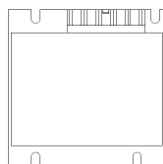
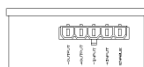

Protegidis contra cortocircuito, sobrecalentamiento e inversión de polaridad, entrada de habilitación, protección IP67, 108x108x43mm

62245001	Convertidor 500W 35-120V A 13,8V +enable	350,00
622SV245	Convertidor 500W 35-120V A 28V +enable	350,00



Convertidor HV Air Cooled 220-800V

62211143	Convertidor 1200W 220-800V a 13,8V	2.075,00
----------	------------------------------------	----------

14.- CARGADORES DE BATERÍA DE ALTA FRECUENCIA IES

2024

Cargador a prueba de limpiezas a alta presión



GAMA ELIPS Voltage universal 120-230Vac IP66 para aplicaciones climáticas severas

ELIPS24V10A	24V.10A. 55Ah-	-100Ah	217x117x69mm	255,00
ELIPS24V15A	24V.15A. 80Ah-	-150Ah	217x117x69mm	255,00
ELIPS24V30A	24V.30A. 180Ah-	-230Ah	280x126x66mm	348,00
ELIPS48V30A	48V.30A. 160Ah-240Ah-300Ah		264x210x210mm	650,00
ELIPS72V21A	72V.21A. 140Ah-200Ah-260Ah		264x210x210mm	715,00

CARGADORES ESPECIALES

Ref.constructor

3603531025	CHE2301463	LINDE 24V 30A +Leds externos	275,00
3793531009	CHE2302994	LINDE 24V 30A +Leds externos	275,00
3603531031	CHE2303012	LINDE 24V 30A +Leds ext.-maintenance free battery	275,00
3723531001	CHE2303013	LINDE 24V 30A +Leds ext.-maintenance free battery	275,00
	CRLED03022	INDICADOR externo LINDE Leds verde/rojo	15,00
2440316740	CHE+0008752	24V 35A +SB50+Leds externos	275,00
	FLPLA04226	INDICADOR externo HAULOTTE c/cable gris	15,00

19.- FAROS Y LUCES PARA SEGURIDAD EN LOGÍSTICA

2025



Faro dos ojos Blue Spot - Punto Azul o Rojo

18438451	Faro LED Punto Azul 12-80V	120,00
SEV2000R	Faro LED Punto Rojo 12-80V	120,00



Faro Raya perimetral Azul o Rojo

18438442	Luz perimetral Roja 12-80V CURTIS (=D14358)	95,00
D14357	Luz perimetral Azul 12-80V	95,00



Faro HALO perimetral ovalado Azul o Rojo

18438480	Luz perimetral ovalada Roja 12-80V	124,00
18438481	Luz perimetral ovalada Azul 12-80V	124,00



Faro Flecha Azul o Rojo

EW2010B	Luz FLECHA Azul 12-60V	130,00
EW2010R	Luz FLECHA Roja 12-60V	130,00

ALARMAS DE MARCHA ATRÁS MULTIFRECUENCIA (sonido blanco)

2025



	Medidas: 102 x 71 x 40mm	
EA5820	Bitensión 12/24V 82dB	78,00
EA5050	Bitensión 12/24V 87dB	74,00
EA5920	Bitensión 12/24V 92dB	106,00
EA5200	Bitensión 12/24V 97dB	135,00

FAROS SERIE ECONOMICA - Rotativos y Destellantes

2025



Conexión 3 puntos - Altura 120mm x Ø147mm - CARRETILLAS		
469040	Faro DESTELLANTE 10-100V	33,00
Conexión DIN flexible - Altura 230mm x Ø135mm conforme a norma ECE R65 y 72/245/EEC "e"		
304.000	Faro ROTATIVO base Flexible 12-24V -LBB772	48,00
Conexión Magnética - Altura 177mm x Ø143mm - conforme ECE R65		
305.000	Faro ROTATIVO base IMAN 12-24V -LBB760K	54,00

NUEVO FARO LED SERIE DELTA-LED - conforme a Norma ECE R65

Función destellante (doble destello), 10-30V, 12 LEDs, 120 destellos/minuto, protección IP65
Consumo: 1,5A @ 12V - 0,75mA @24V - Temperatura de trabajo -20° a +50° - 15 tipos de flash

2024

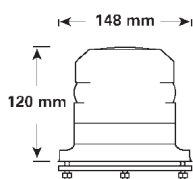

EB5001A	Conexión 3 puntos	98,00
DB5002A	Conexión 1 punto	125,40
DB5003A	Conexión DIN	125,40
DB5004A	Base Magnética + conexión mechero	152,00

FAROS DE TRABAJO DE LED

2025



FAROS DE TRABAJO DE LED		
EW2461	5 x 3W LEDs - 650 lumens 10-30V 195 x 115 x 100mm + Base Magnética + Batería + Cargador toma mechero	163
EW2401	5 x 3W LEDs - 600 lumens 10-30V IP67 Flood 66 x 66 x 66mm	77
EW2470	5 x 3W LEDs - 600 lumens 10-30V IP67 Flood 85 x 85 x 42mm	49
E92007-E	5 x 3W LEDs - 500 lumens 10-30V 110 x 128 x 46mm	57
EW2101	6 x 3W LEDs 1650 lumens 10-30V IP67 110 x 110 x 55mm - Flood	85

Ovalado 135x80mm, soporte inferior, salida cable

E92001	6 Leds 3W, 12-24V	200,00
E92002	7 Leds 3W, 12-24V, luz tipo Spot - largas	208,00

Redondo, soporte inferior, salida cable

E92004-E	6 x 3W LEDs - 800 lumens 10-30V IP67 Flood 116 x 116 x 48mm	51,00
E92014	9 Leds 3W 10-30V 125x125x50mm 2000 lumens Flood	93,00

Redondo 125x125mm, ultrafino:50mm

EW2501	5 x 10W LEDs - 2900 lumens 10-30V IP67 Flood 98 x 145 x 79mm	194,00
--------	--	--------

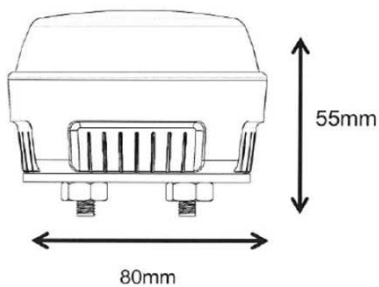

Faro plano XENÓN, IP67 - Altura 55mm x Ø80mm

30102270	2W 10-100V AMB.	47,30
30102470	2W 10-100V AZUL	47,30
30102370	2W 10-100V ROJO	47,30
30102570	2W 10-100V VERDE	51,70
30105270	5W 10-100V AMBAR	72,00
30105470	5W 10-100V AZUL	72,00
30105370	5W 10-100V ROJO	72,00
30105570	5W 10-100V VERDE	80,00
Versiones sincronizables:		
30112270	2W 10-30V AMBAR	72,00
30112470	2W 10-30V AZUL	72,00
30112370	2W 10-30V ROJO	72,00
30112570	2W 10-30V VERDE	80,00
30115270	5W 10-30V AMBAR	80,00
30115470	5W 10-30V AZUL	80,00
30115370	5W 10-30V ROJO	80,00
30115570	5W 10-30V VERDE	88,00

Faro LP LED - Función 1 destello y luz continua - Protección IP67

445002	10-100V AMBAR	81,00
445003	10-100V ROJO	81,00
447002	110Vac/230V.ac AMBAR	81,00
447003	110Vac/230V.ac ROJO	81,00

FARO LT - Un destello - Protección IP67

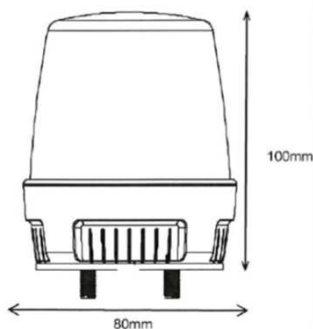

Faro alto XENÓN, IP67 - Altura 100mm x Ø80mm

31102270	2W 10-100V AMBAR	61,00
31102470	2W 10-100V AZUL	61,00
31102370	2W 10-100V ROJO	61,00
31102570	2W 10-100V VERDE	61,00
31105270	5W 10-100V AMBAR	76,00
31105470	5W 10-100V AZUL	76,00
31105370	5W 10-100V ROJO	76,00
31105570	5W 10-100V VERDE	76,00

Faro LT LED - Función 1 destello y luz continua - Protección IP67

446002	10-100V AMBAR	88,00
446003	10-100V ROJO	88,00
448002	110Vac/230V.ac AMBAR	116,00
448003	110Vac/230V.ac ROJO	116,00

ALARMAS DE MARCHA ATRÁS DE PEQUEÑO FORMATO

para pequeño vehículo (traspaletas, apiladores, carretillas, vehículos de limpieza)

2025



Medidas: Diámetro posterior 43mm x fondo 45mm - Consumo: 0,03A

201120	Alarma de rosca Ø28 12-48V.RAPIDO	22,70
202120	Alarma de rosca Ø28 12-48V.LENTO	22,70
204120	Alarma de rosca Ø28 12-48V.Doble sonido	23,80
208120	Alarma de rosca Ø28 12-48V.Fuerte+Fijo	22,70
209120	Alarma de rosca Ø28 12-48V.Medio+Fijo	22,70

Medidas: 102 x 51 x 36mm

126-001	ARI BI-TENSION 12/24V 97dB	28,00
---------	----------------------------	-------

Medidas: 102 x 71 x 40mm

585-000	MULTITENSION 12/48V 97dB	42,00
580-000	MULTITENSION 12/80V 87dB	46,00

Autoajustables - siempre suenan 5dB por encima el sonido ambiente

SA951	Alarma AUTOAJUSTABLE 12/48V 77-97dB	65,00
SA950	Alarma AUTOAJUSTABLE 12/24V 82-102dB	86,00
DF532	DOBLE TONO 12/24V 102dB sonidos diferentes en tracción y elevación	85,00

Night Reduction - para ajustar sonido por switch or conexión a luces

515-003	Alarma ajustable manualmente 78-90dB 12/24V	60,00
520-003	Alarma ajustable manualmente 87-97dB 12/24V	68,00

ALARMAS DE MARCHA ATRÁS DE MEDIANO Y GRAN FORMATO

para vehículos de obras públicas, puertos-aeropuertos, gruas, minas, camiones

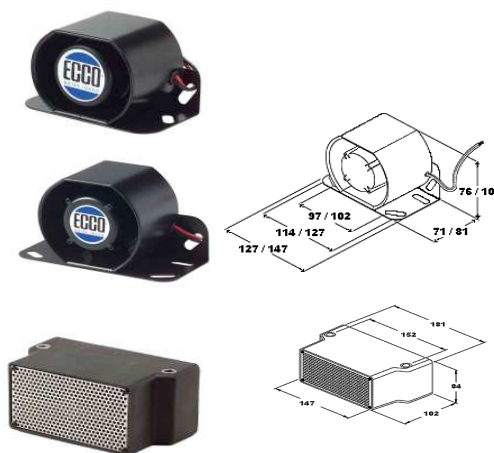

Medidas: 127 x 76 x 71mm - Consumo: 0,6-0,7A

630-001	MULTITENSION 12/36V 107dB	118,00
<i>- Consumo: 0,3-0,4A</i>		
SA931	Alarma AUTOAJUSTABLE 12/48V 82-102dB	135,00

Medidas: 147 x 102 x 81mm - Consumo: 0,7-0,9A

SA917	Alarma AUTOAJUSTABLE 12/24V 87-112dB	138,00
-------	--------------------------------------	--------

Medidas: 181 x 84 x 102mm - Consumo: 0,4A

767 REVO	Alarma AJUSTABLE 12/36V 97dB o 112dB	188,00
SA920	habituales de CATERPILAR, JCB, KOMATSU	

- ✓ Índice de protección elevado IP67 y IP68
- ✓ Temperaturas de trabajo de -40°C a +85°C
- ✓ Tamaño muy reducido
- ✓ Conforme a las normativas europeas
- ✓ Protección contra inversión de polaridades
- ✓ Modelos multitensión, bisonoros (2 tonos diferentes), con selector día/noche y autoregulables en dB

CCTV - Cámaras con leds de infrarrojos para visión nocturna y pantallas planas color TFT LCD para la marcha atrás y la visión de ángulos muertos en carretillas, furgonetas y camiones, autocares, caravanas, camiones de basura, maquinaria pesada y de obra pública

2025



NUEVO KIT CCTV

K7000B - Kit PANTALLA 7" - 12-24V

395

Kit CCTV con monitor LCD color 7" alta resolución con controlador interno, cámara infrarrojo con protección IP69K, mando a distancia.

Se pueden instalar hasta 2 cámaras.

Kit incluye: M7000B Monitor
C2013B Cámara
TC20-4B Cable de 20m

140-550 - Kit PANTALLA TÁCTIL 5" **530**

140-750 - Kit PANTALLA TÁCTIL 7" **895**

Repuestos disponibles: Permite hasta 3 cámaras

141-950 Pantalla táctil color 5"

141-970 Pantalla táctil color 7"

DAC1006 Cámara color

DAC1016 Cable de 20m

DAC1022 Delta Susi kit



DAC1001 - Kit ESTANDAR 5.6" -140-520 **675**

Compuesto por: Permite hasta 4 cámaras

141-006 Pantalla color 5,6" 12-24V, audio, sensor día/noche, 165x115x29

142-003 Cámara color IP68, 18 IR LEDs visión nocturna, audio

143-004 Cable de 20m protegido para exterior



DAC1002 - Kit GRAN VISION 7" -140-730 **925**

Compuesto por: Permite hasta 4 cámaras

141-008 Pantalla color 7" 12-24V, audio, sensor día/noche, 200x115x29

142-003 Cámara color IP68, 18 IR LEDs visión nocturna, audio

143-004 Cable de 20m protegido para exterior



NUEVO KIT GRAN PANTALLA 10.1' QUADVIEW 4 cámaras

BR-TQS1001 - Kit PANTALLA 10.1" + 1 cámara - 12-24V **850**

BR-TQS1001x4 - Kit PANTALLA 10.1" + 4 cámaras - 12-24V **1.290**

Kit CCTV con monitor LCD color 10.1" alta resolución, controlador interno x4 cámaras, cámara infrarrojo con protección IP69K, mando a distancia.

Se pueden instalar y visualizar hasta 4 cámaras simultáneas

Kit compuesto por:

BR-TMS1001 Monitor + soporte VESA robusto

RV16 Cámara inox, visión nocturna

TC20 Cable de 20m



Una solución para cada vehículo: amplio abanico de cámaras y pantallas para crear el kit a medida

- ✓ **Kit Pantalla táctil:** incluye una cámara con protección **IP69K**
- ✓ **Visión múltiple:** 5'6" y 7" permiten **hasta 4 cámaras** con una pantalla y 6 formatos de cámara diferentes
- ✓ Última tecnología con pantallas con **controladores incorporados:** simple y rápida instalación
- ✓ Cámaras a color con **tecnología CCD de Sony**, con control de tonos, contrastes y luminosidad
- ✓ **Arranque/selección** de cámara principal **automático** (al poner la marcha atrás por ejemplo)
- ✓ **Altavoz y micrófono** incorporados con control de volumen
- ✓ **Extensión** para pulsador de cambio de pantalla en **panel del vehículo**
- ✓ Resistencia mecánica a vibraciones: pantallas 3G y cámaras 8G
- ✓ Temperatura de trabajo: pantallas -15° a +65° y cámaras -30° a +65°

Garantía de 2 años

BARRAS DE LUCES DIRECCIONALES DE LED

Vehículos mantenimiento vía pública, ambulancias, policía y otros vehículos especiales

2025

Tecnología LED de larga vida, bajo consumo, sin mantenimiento

BARRA DIRECCIONAL DE LED SERIE 3410

	Volt, /	Max Current /	Cable	P.V.P.
3410A -	12V	3,0A	4,50m	890,00



3410



ED3315

BARRA DIRECCIONAL LED SERIE ED3300 12-24V

	Volt, /	Max Current /	Cable	P.V.P.
ED3315A	12-24V	2,4A	4,6m	1.030
ED3335A	12-24V	2,4A	10,6m	1.080
ED3355A	12-24V	2,4A	16,7m	1.110

Principales Características

- Carcasa de aluminio estructurado y módulos LED de policarbonato claro (iluminación ambar)
- 8 módulos reflectantes con 6 LEDs
- SAE J845 Class I, homologada CE y ECE R10

8 opciones de destello preprogramados

LEFT ARROW (LI)	LEFT ARROW SOLID (LS)	RIGHT ARROW (RI)	RIGHT ARROW SOLID (RS)	CENTRE OUT (CI)
LEFT (LI)	LEFT SOLID (LS)	RIGHT (RI)	RIGHT SOLID (RS)	CENTRE OUT SOLID (CS)
ALTERNATING QUAD FLASH (AQF)	WIG WAG (WW)	ALTERNATING SINGLE FLASH (ASF)		

KEY
 Pattern available for Halogen Safety Directors
 Pattern available for LED Safety Directors

Principales Características

- Medidas: 1232 x 51 x 76mm
- Carcasa de aluminio estructurado y módulos LED de policarbonato claro (iluminación ambar)
- 8 módulos reflectantes con 20 LEDs

LUCES DIRECCIONALES DE LEDs 12-24V para fijar o empotrar - Serie ED3703 Multi Flash 3 LEDs

ED3703A (3736A) Ambar	60,00	
ED3703B (3736B) Azul	60,00	
ED3703R (3736R) Rojo	60,00	
ED3703C (3736C) Blanco	60,00	

Medidas 93 x 35 x 15mm



LUCES LATERALES DE LED STICK-A-LED - fijación adhesiva



3 LEDs - 12-24V

	ED0002A - ovalada	78,00
	ED0002B - ovalada	78,00
	ED0002C - ovalada	78,00
	ED0002R - ovalada	78,00
	ED0003A - triangular	78,00
	ED0003B - triangular	78,00
	ED0003C - triangular	78,00
	ED0003R - triangular	78,00

6 LEDs - 12-24V

	ED004A - rectangular	108,00
	ED004B - rectangular	108,00
	ED004C - rectangular	108,00
	ED004R - rectangular	108,00

Sev85

Tu partner Tecnológico desde 1985

Product Range



Product Range



SEV85

C/ Jules Verne, 5 - 08006 Barcelona - Spain
Tel:+34 93 226 20 85 info@sev85.com

www.sev85.com

